

# Inter-American Photochemical Society Newsletter



I-APS Internet Address <http://www.chemistry.mcmaster.ca/~iaps>

This newsletter is available in pdf format from the web site.

**Volume 23 Number 2**

**November 2000**

I-APS Officers	2
Advisory committee members	3
Letter from the President	4
Michael Rogers 2001 I-APS Award Recipient	6
George Hammond Honored With ACS Symposium	9
XII International Photochemistry Conference	10
XIII International Photochemistry Conference	12
A New Mechanism for Photosensitization of Photographic Materials: A Technological Application of Radical-Ion Chemistry. Ian Gould	13
The Photochemistry of Heteroaromatic Compounds. James W. Pavlik	22
Metal Nanoparticles. How Noble Are They in the Light, Prashant V. Kamat	34
Understanding Photocleavage and Controlling Photocycloaddition, Steve Fleming	43
From Photochemistry to Strained Molecules... and Back Again, Richard P. Johnson	55
Upcoming Meetings	64
Application	66

## I-APS Officers

### President

Fredrick D. Lewis  
Department of Chemistry  
Northwestern University  
Evanston, IL 60208-3113  
[lewis@chem.nwu.edu](mailto:lewis@chem.nwu.edu)

### Vice President

Edwin F. Hilinski  
Department of Chemistry  
Florida State University  
Tallahassee, FL 32306  
[hilinski@chem.fsu.edu](mailto:hilinski@chem.fsu.edu)

### Secretary

Steven A. Fleming  
Department of Chemistry  
Brigham Young University  
Provo, UT 84602  
[fleming@byu.edu](mailto:fleming@byu.edu)

### Treasurers

Lisa Kelly (USA)  
Department of Chemistry and Biochemistry  
University of Maryland, Baltimore County  
100 Hilltop Circle  
Baltimore, MD 21250

Cornelia Bohne  
Department of Chemistry  
University of Victoria  
P. O. Box 3055  
Victoria B. C.  
Canada V8W 3P6  
[bohne@uvic.ca](mailto:bohne@uvic.ca)

Frank H. Quina (South America Secretary)  
Instituto de Química  
Universidade De São Paulo  
São Paulo, Brazil  
[frhquina@quim.iq.usp.br](mailto:frhquina@quim.iq.usp.br)

## Advisory Committee

Cornelia Bohne  
Department of Chemistry  
University of Victoria  
P. O. Box 3055  
Victoria, B. C.  
Canada V8W 3P6  
[bohne@uvic.ca](mailto:bohne@uvic.ca)

Pedro F. Aramedia  
INQUIMAE. Departamento De Química Inorgánica  
FCEN. Universidade Buenos Aries  
Pabellón 2. Ciudad Universitari  
1428 Benos Aires  
Argentina  
[pedro@qi.fcen.uba.ar](mailto:pedro@qi.fcen.uba.ar)

Ian R. Gould  
Department of Chemistry  
Arizona State University  
Box 871604  
Tempe, AZ 95287-1605  
[igould@asu.edu](mailto:igould@asu.edu)

Gerald J. Meyer  
Department of Chemistry  
The John Hopkins University  
3400 North Charles Street  
Baltimore, MD 21218  
[Meyer@JHUVMS.HCF.JHU.Edu](mailto:Meyer@JHUVMS.HCF.JHU.Edu)

Irene E. Kochevar  
Department of Dermatology  
Massachusetts General Hospital WEL-224  
Harvard Medical School  
Boston, MA 02114  
[kochevar@helix.mgh.harvard.edu](mailto:kochevar@helix.mgh.harvard.edu)

Mary K. Boyd  
Department of Chemistry  
Loyola University Chicago  
6525 North Sheridan Road  
Chicago, IL 60626  
[mboyd@luc.edu](mailto:mboyd@luc.edu)

### Newsletter Editor

William S. Jenks  
Department of Chemistry  
Iowa State University  
Ames, Iowa 50011-3111  
[wsjenks@iastate.edu](mailto:wsjenks@iastate.edu)

### IAPS Webmaster

William Leigh  
Department of Chemistry  
McMaster University  
1280 Main Street West  
Hamilton, ON L8S 4M1  
Canada  
[leigh@mcmaster.ca](mailto:leigh@mcmaster.ca)

**Frederick D. Lewis**  
**Department of Chemistry**  
**Northwestern University**  
**Evanston, IL 60208-3113 USA**



**phone: 847-491-3441**

**fax: 847-467-2184**

**email:**

**lewis@chem.northwestern.edu**

October 19, 2000

Dear Colleagues:

At some point in mid-summer a large, battered cardboard carton containing the files of our Society arrived in my office. Its arrival signaled the transfer of "Presidential" duties from Linda Johnston in Ottawa to my overcrowded office in Evanston. No ceremony, no oath of office, no presidential ball - just a cardboard carton. To quote our former president, Dave McMillin, "We are not a wealthy Society". You may recall that in my campaign for Vice-President three years ago I promised to fight for every working photochemist - not just the top one percent. So now it's time for me to get to work on your behalf.

It is my pleasure to officially thank Linda Johnston for the splendid leadership that she has provided the Society during the past two years. Linda's superb organization and quiet sense of humor made board meetings almost enjoyable and kept the Society running smoothly. I also want to thank three members of the Advisory Committee who have completed their four year terms, Lisa McElwee-White, Frank Quina, and Dick Weiss. Linda and I relied upon their advice on the important decisions made by the Society. The Society's Secretary, Russ Schmehl, and Newsletter Editor, William Jenks, are also completing their terms of service to the Society. These jobs are time-consuming and essential to the functioning of the Society. Thanks are due to Russ and William for jobs well done.

Those of you who read the May 2000 Newsletter or looked at the Society's website know that Ed Hilinski was elected Vice President (President Elect) last Spring. I look forward to working with Ed during the next two years and know the Society will be in good hands two years from now when I mail him the presidential cardboard box. I also look forward to working with the newly elected Secretary, Steve Fleming, and members of the Advisory Board, Pedro Aramendia, Mary Boyd, and Gerald Meyer, as well as the continuing members of the Board and the Society's Treasurers and Webmaster. I am pleased to announce that Linda Peteanu has agreed to take on the editorship of our Newsletter beginning with the May 2000 issue.

I would like to call your attention to announcements that appear in this Newsletter concerning the 2001 I-APS Meeting to be held in Cordoba, Argentina and the 2002 Meeting to be held in Tempe, Arizona. Registration materials for the Cordoba meeting are posted on the Society's web site. Please note that the registration deadline

in November 30, 2000. Your attendance is essential to the success of our meetings, so please make plans now to attend both the Cordoba and Tempe meetings. The participation of students is encouraged at all of our meetings. Another announcement of special interest is the selection of Mike Rodgers as recipient of the 2001 I-APS Award. Having served as chair of the Awards Committee for the past two years I have been impressed by the high quality of the nominations that have been submitted for this award. Congratulations Mike!

On the international front, the IUPAC Commission on Photochemistry will cease to exist next year as part of a large-scale reorganization of IUPAC. Silvia Braslavsky will continue to serve as a member of the Organic Chemistry Division of IUPAC and will be the only link between the international photochemistry community and IUPAC. Acting on a suggestion by Dick Weiss, currently Chair of the IUPAC Commission on Photochemistry, the three major photochemical societies (I-APS, EPA, and JPA) have decided to establish an Inter-Society Committee on Photochemistry. The I-SCP will represent the three societies in dealings with IUPAC and other issues of interest to all three societies. After consulting our Advisory Board on the merits of establishing this committee, I have ask Dick Weiss and Cornelia Bohne to serve as I-APS representatives on the six-member Committee. The presidents of the three societies will also serve as ex-officio members. I view the establishment of I-SCP as a welcome first step toward increased international cooperation between photochemists.

The coming two years promise to be exciting ones for our Society. I encourage each of you to share in the excitement.

Best regards,

Fred Lewis

**2001 I-APS Award in Photochemistry: Michael A. J. Rodgers**

Professor Michael A. J. Rodgers, Ohio Board of Regents Eminent Scholar, Center for Photochemical Sciences, Bowling Green State University is the winner of the 2001 I-APS Award in Photochemistry. The award recognizes Mike's contributions to the fields of photochemistry and photobiology during the last ten years. Rodgers is best known for the development and application of fast kinetic methods for the study of photochemical processes. His recent research has centered on studies of singlet oxygen and the development of photodynamic therapy for the treatment of cancers. Mike is past-president of the American Society for Photobiology and winner of that society's Research Award in 1997. He has also been an active member of I-APS, serving a term on the Advisory Committee. A biographical sketch appears on the next page.

**Michael A. J. Rodgers Recipient of the 2001 I-APS Award  
Recipient of the 2001 I-APS Award**

Department of Chemistry and Center for Photochemical Sciences  
Bowling Green State University  
Bowling Green, OH

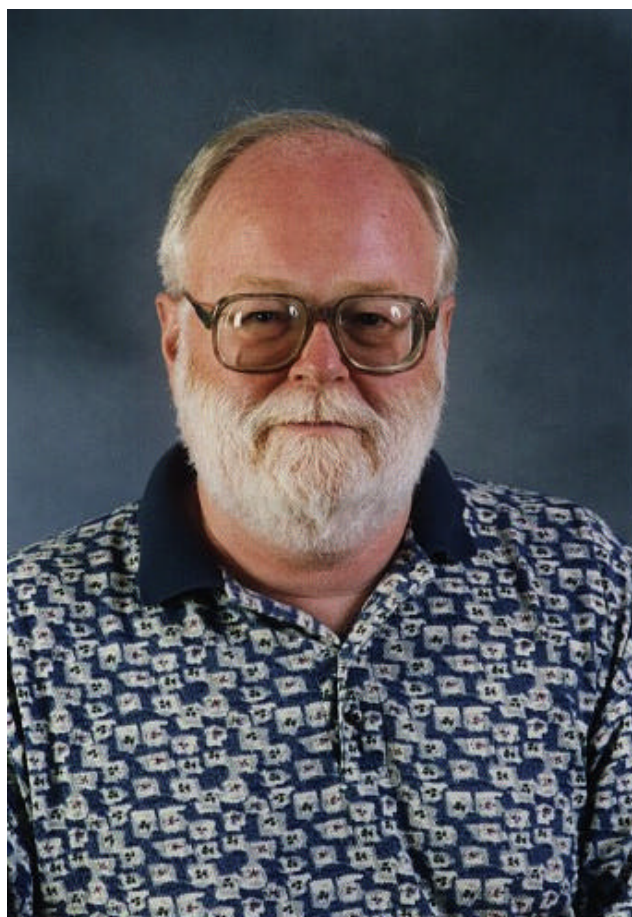

Mike Rodgers' title at Bowling Green is "Eminent Scholar & Professor." How appropriate a title for the winner of the 2001 IAPS Award. Mike has been a central part of the Center for Photochemical Sciences there since 1988, and was similarly a central force at the CFKR at UT Austin for a dozen years before that.

Rodgers is one of the very top fast kineticists and photophysicists in the world. He is known not just for the development of instrumentation, but also for the development of very careful analyses. He outlined the

methodology so that in studying photochemical processes, scientists could use fast kinetics correctly and avoid the pitfalls that artifacts may introduce. And, importantly, he made all these techniques available to colleagues throughout the world.

Aside from his own outstanding research program, Mike is an extraordinary collaborator. He has a knack of making other people's science grow and develop, and this is an important reason the Center for Fast Kinetics was so successful. That period saw Mike and the Center teach a lot of us how to do transient spectroscopy in the finest scientific spirit. The society owes Mike a specific debt of training in that one of his Ph.D. students at Bowling Green, Lisa Kelly, is the Society's North American treasurer. Another student of his, Elizabeth Morlino, was a Closs Award winner a few years ago.

Mike is, of course, best known for his work with photosensitizers for photodynamic therapy. Rodgers has been and is currently involved in the development and evaluation of new compounds for use in various cancer therapies. His previous work on the metallo-centered naphthalocyanines, in collaboration with Malcolm Kenney at Case Western and Giulio Jori in Italy illustrates a strength of Mike's style. He discovered Kenney's dyes as potential infrared absorbers as sources of singlet oxygen for photodynamic effects in an issue of JACS and knew that was just what was needed. He sought Kenney out, convinced him to collaborate, and the two of them developed what has now become a new series of photodynamic dyes developed for study in a number of additional tumor protocols. (Jori does the *in vitro* testing.) This collaborative effort is pushing the envelope of photothermal therapy by investigating the effects and ramifications of depositing heat spikes in biological materials using near IR lasers and strongly absorbing photosensitizing agents. At one level – where Rodgers is the leader – the investigation is fundamental photophysics – trying to establish a predictive understanding of how the molecular composition of the macrocycles influences the deactivation of their excited states. On another level, they examine the mechanism by which the photothermal damage occurs, at what sites, and how such sites can be targeted.

Rodgers is an active citizen in the field in other ways as well. He has been the president of the American Society for Photobiology (ASP) and has served on the Editorial Board of *Photochemistry and Photobiology*. He was twice program chair for the ASP annual meetings. He was the American Society for Photobiology Sigma Xi National Lecturer for 1996-1997. He also served a term as chair of the Chemistry Department at BGSU.

**Symposium Honors George Hammond's 80th Birthday**

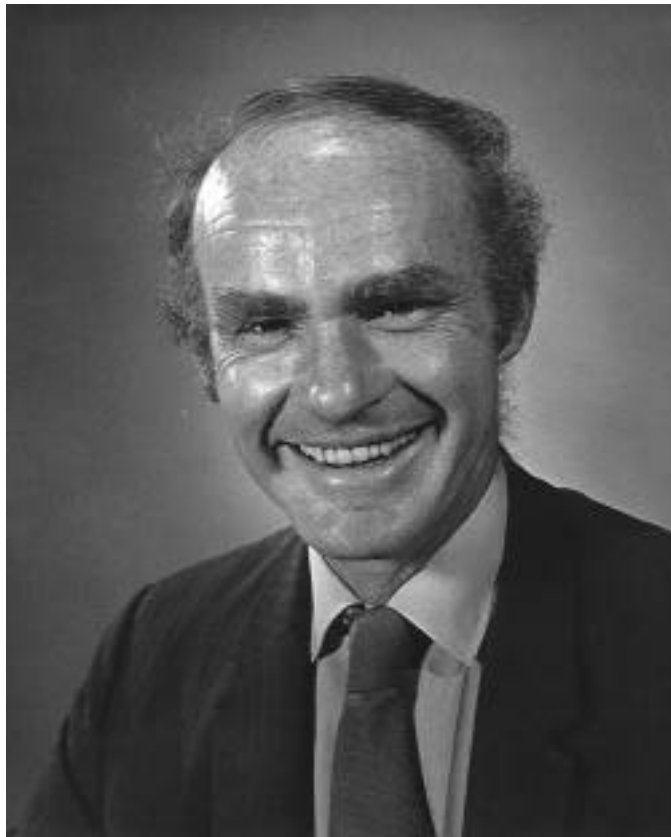

"Photochemistry Becomes More Complex" will be a symposium in the Organic Division at the ACS National Meeting in San Diego, April 1-5, 2001. Carl Wamser is organizing the symposium, which is meant to coincide (approximately) with George Hammond's 80th birthday. Divisional rules prohibit dedicating a symposium to an individual except in specific circumstances, but this is definitely intended to be a celebration of the progress of photochemistry as influenced by George Hammond. The confirmed list of speakers includes Dave Eaton, Harry Gray, Jay Kochi, Nate Lewis, Eve Menger, Doug Neckers, Tom Penner, Nick Turro, Dick Weiss, and Jim Yardley. The symposium will be on Monday afternoon and Tuesday afternoon, April 2-3, and there will be some informal gatherings as well. All students, colleagues, and friends of George are encouraged to come and join the festivities. As plans are finalized, further details will be available at:

<http://chem.pdx.edu/~wamserc/Hammond/>

## XIIth INTER-AMERICAN PHOTOCHEMICAL SOCIETY CONFERENCE



ASCOCHINGA, CORDOBA, ARGENTINA, MAY 20-25, 2001

**November 30** is the deadline for early registration and hotel reservation for the meeting. This date is also the deadline for abstract submission.

Both can be performed electronically at the address.

<http://www.fcq.unc.edu.ar/iaps2001>

FEES INCLUDE THE FIRST DAY OF HOTEL, FULL ACCOMMODATION

	Before Nov 30	Before March 31	After March 31
Active participant	175	185	195
IAPS Affiliate Member	165	175	185
Student	100	110	120
Accompanying person	70	80	90

### Invited Speakers:

David G. Whitten (USA), Matthew S. Platz (USA), Ana L. Moore (USA), J. C. Scaiano (Canada), Françoise Winnik (Canada), William Leigh (Canada), Marcelo Ganzarolli de Oliveira (Brasil), Andrés Olea (Chile), Silvia E. Braslavsky (Germany), Elizabeth Jares-Erijman (Argentina), José Manuel Riveros (Brasil), Michael R. Wasielewski (USA), Robert J. McMahon (USA), Paul F. Barbara (USA), W.G. McGimpsey (USA), John P. Toscano (USA), Guilherme L. Indig (USA), Norman A. García (Argentina), Oscar Martínez (Argentina), Christopher Foote (USA), Clifford P. Kubiak (USA), Franklin D. Saeva (USA), Irene Kochevar (USA), John R. Scheffer (Canada), Henrique Eisi Toma (Brasil), María Victoria Encinas (Chile), Guillermo Bazan (USA), Luis Alberto Montero (Cuba), Timothy Wallington (USA).

Please, visit our Web page where you will also find information on:

### Accommodations

The Conference will take place in a Hotel in the hills, specially booked for the Congress. The rate of \$50 per person per day (equivalent to US\$ 50) includes room, breakfast, lunch and dinner

### **The Meeting Place**

Ascochinga is a small village in the hills of Central Argentina, 57 km to the north of the city of Córdoba, and 40 km from its International Airport. Córdoba is the second largest city in Argentina. It is located 700 km NW of Buenos Aires.

### **Travel and Useful Tips**

You can fly directly to Córdoba via Brazil (probably the best choice), Chile, Bolivia or Cuba. Through Buenos Aires, international flights arrive at "Ezeiza International Airport". Flights to Córdoba depart from "Jorge Newbery Domestic Airport". Transfers can be achieved by bus (\$15), taxis or limousines (\$50 to \$60).

### **Pre and post symposium tours**

The time of the year is ideal for visits to Iguazu falls or the Northwest of Argentina, where old indian and spanish towns are still preserved.

We hope to see you in Córdoba

Sincerely

### **ORGANIZING COMMITTEE**

Miguel García Garibay(USA), co-chair; Pedro Aramendía (Argentina), co-chair; Gerardo Argüello (Argentina); Gustavo Argüello (Argentina); Cornelia Bohne (Canada); Carlos Chesta (Argentina); Frank Quina (Brazil); Robert Redmond (USA); Russel Schmehl (USA); Richard Weiss (USA).

**THIRTEENTH INTER-AMERICAN PHOTOCHEMICAL SOCIETY WINTER  
CONFERENCE**

Arizona State University  
Tempe, Arizona

January 2-5, 2002  
*Mark your calendars now!*

The Thirteenth Winter Conference of the Inter-American Photochemical Society will be held on the campus of Arizona State University in Tempe, AZ. The conference will begin on the evening of Wednesday January 2nd, and will end on the evening of Saturday January 5th, allowing conferees to return home Sunday January 6th.

Conference accommodation will be at the Tempe Twin Palms hotel on the edge of campus, at a rate of \$95 for singles and \$105 for doubles. The hotel provides a 24 hour complimentary shuttle to and from the Phoenix Sky-Harbor International airport.

The weather in Tempe in January is invariably beautiful, with warm sunny days and cool, dry evenings.

More detailed information will be posted here and on the society web site. For immediate information, please contact the organizers:

Ian R. Gould  
Department of Chemistry and Biochemistry  
Arizona State University  
Tempe, AZ 85287-1604  
(480) 965-7278  
igould@asu.edu

Peter C. Ford  
Department of Chemistry  
University of California, Santa Barbara  
Santa Barbara, CA 93106  
(805) 893-2443  
ford@chem.ucsb.edu

## A New Mechanism for Photosensitization of Photographic Materials. A Technological Application of Radical-Ion Chemistry.

**Ian R. Gould, Department of Chemistry and Biochemistry, Arizona State University, Box 871604, Tempe, AZ 85287-1604.**

**Samir Farid, Research Laboratories, Eastman Kodak Company, MC 02109, Rochester, NY, 14650-2109.**

**I. Introduction.** Silver halide photography probably represents the most complex technological application of organic chemistry.<sup>†</sup> Modern photographic films consists of ca. 10 - 15 layers with a total thickness of only ca. 20  $\mu\text{m}$ , containing over 100 different organic compounds. The different layers are designed to give the film appropriate sensitivity to the different spectral regions, blue, green and red. Despite the fact that photography has a long history of research, there is still a great deal that is not well understood. The light-induced image capture events and subsequent image development involve a wide range of homogeneous and heterogeneous photochemical and thermal chemical and physical processes. Many of these are interdependent, which makes implementation of any fundamentally new process in photography a daunting prospect. If an "Edisonian" approach is to be avoided, any new proposal must have a firm mechanistic background. Here we describe a new mechanism for photosensitization of silver halide materials, two-electron sensitization (TES), which has the capability of doubling their photon sensitivity. The new approach is based on an understanding of radical cation chemistry as described in the literature, and in particular on new radical cation chemistry developed at the Eastman Kodak Company and at the NSF Center for Photoinduced Charge Transfer at the University of Rochester. In this article we first provide a brief overview of how color photography works. The new sensitization scheme is then described, with an emphasis on the molecular requirements. Finally, some aspects of radical cation chemistry important to the new sensitization scheme are discussed, and the properties of several useful compounds are described.

**Scheme I.** Structures of typical sensitizing dyes.

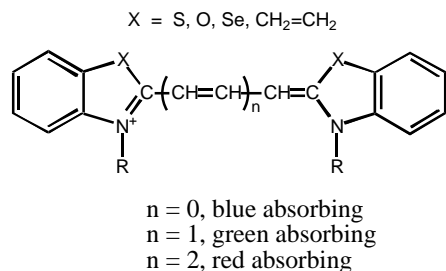

**II. Overview of the Photographic Process.** The most important photoactive component of photographic film is silver halide, either as the chloride, bromide or bromide with added iodide and/or chloride. The silver halide is in the form of microcrystals that are suspended in a gelatin medium at a density of a few million per square millimeter. The image capture process relies on

<sup>†</sup> Detailed discussions of many aspects of photographic chemistry can be found in, *The Theory of the Photographic Process*, 4th Edition; James, T. H., Ed.; Macmillan: New York, 1977.

photoinduced reduction of silver ions in the silver halide microcrystal to form a small stable speck of metallic silver. Silver halides are semiconductors with band gap absorptions in the ultraviolet and which tail into the blue region of the visible spectrum. The reduction of the silver ions can be induced by direct band gap absorption of light by the silver halide. Absorption results in the formation of conduction band electrons, which can be trapped, most commonly by interstitial silver ions. In practical photographic systems, however, a photosensitization mechanism is usually employed. To provide sensitivity to the entire visible spectrum, dyes are adsorbed to the surface of the silver halide crystal surface. These sensitizing dyes are usually of one of the classes of cyanines. Typical examples are illustrated in Scheme I.

Cyanine dyes are classified according to the number of methines joining the heterocycles. The simple cyanines have one methylene, and usually have absorption maxima in the blue spectral region. Carbocyanines and dicarbocyanines have 3 and 5 methines, respectively, and generally absorb in the green (carbocyanine) and red (dicarbocyanine) spectral regions. The dyes are usually aggregated on the surface of the crystal in the form of a J-aggregate. The J-aggregates have narrower absorption spectra than the corresponding monomers, allowing for higher spectral selectivity and resulting in higher extinction coefficients at the absorption maxima. Excitation of the adsorbed dyes can lead to transfer of an electron from the excited state to the silver halide, by injection into the conduction band. A schematic illustration of this process is given in Figure 1. Electron injection is expected when the energy of the LUMO of the dye is higher than that of the conduction band of the silver halide, CB. The energies of the CB and valence bands, VB, of silver halide are not known with great accuracy, but a value of ca. -0.9 V vs SCE for the CB is consistent with experimental photographic data.

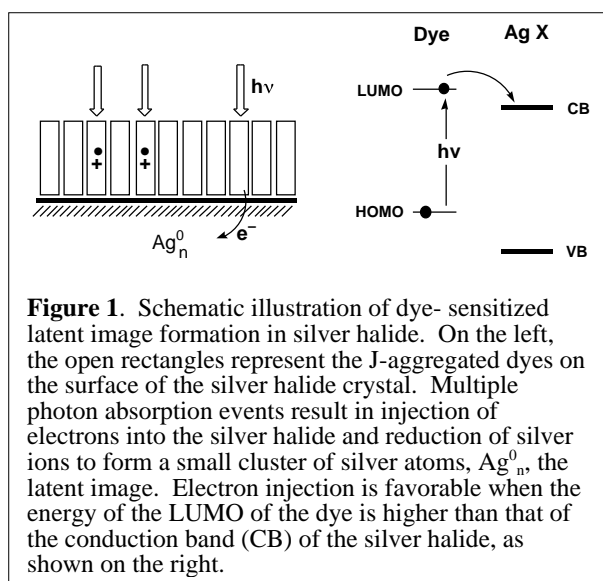

In practical systems, the silver halide is doped with electron traps to reduce the probability of return electron transfer to the photooxidized dye. Even in the presence of such traps, however, a single silver atom is unstable with respect to eventual return electron transfer. With multiple photon absorption events, multiple electrons are injected, and a small cluster of silver atoms can be formed. A cluster as small as four silver atoms is stable with respect to return electron transfer, and once formed serves as the latent image, Figure 1. Otherwise undetectable by conventional analytical methods, the latent image catalyzes the formation of the image dye when the photographic film is developed.

In the development process, a redox activated coupling reaction takes place to form the visible image dye. An electron donor developing agent, often an N,N-dialkyl-1,4-phenylenediamine, reduces the silver ions in the crystal. The oxidized amine then reacts with a coupling reagent to form the image dye. The overall process is shown in Scheme II. Different coupling agents are used to form different colored dyes, typical examples are given in Scheme II. Four silver ions are reduced for each image dye molecule formed. Importantly, the overall process is catalyzed by silver atoms. The development conditions are carefully controlled so that only catalyzed reactions

occur, i.e. reactions take place *only* at those silver halide microcrystals that have been exposed to light and contain a useful latent image. In the development process the entire silver halide crystal is reduced to metallic silver, and  $> 10^9$  image dye molecules are formed from the original four silver atoms! In this way, the original latent image undergoes an enormous magnification. This magnification effect in silver halide is unique among all imaging materials.

Despite this enormous amplification, there exists a need for even more sensitive silver halide materials. In practical systems, approximately 10 - 15 photons are required for formation of the latent image. Thus, roughly

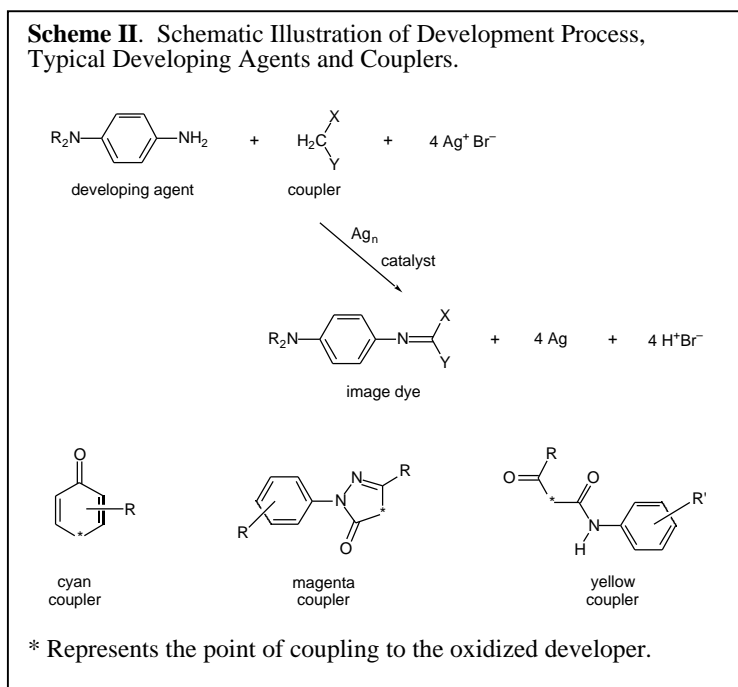

75% of the absorbed photons are wasted. An increase in photon efficiency by a factor of two translates into a doubling of the ASA speed, i.e. 200 speed film becomes 400 speed etc. Any increase in photon efficiency without changing the silver halide grain size would clearly be beneficial. We now describe a new mechanism for sensitization, TES, that is designed to reduce the required number of photons to form a useable latent image, and which has the capability of doubling photographic speed without altering the silver halide grain properties. In principle, TES could allow image capture with fewer than four photons!

**III. Two-Electron Sensitization.**<sup>†</sup> To understand the TES mechanism it is useful to consider the sensitization mechanisms in the manner illustrated in Scheme III. Conventional sensitization is shown as the horizontal reaction sequence in the Scheme. In conventional sensitization, the oxidized dye probably accepts an electron from an electron donor in the gelatin (gel) to generate a radical cation in the medium. The ultimate fate of the  $gel^{++}$  is not known. This is important since it is difficult to rationally control the energy wasting return electron transfer process if the location of the site of oxidation is not known. As mentioned above, considerable effort has been directed towards trapping the electron with dopants in the silver halide. In contrast, the chemistry of the oxidized dye chemistry has received little attention. Thus, the first goal of the new approach is to control the fate of the oxidized sensitizing dye.

The Two-Electron Sensitization mechanism is illustrated as the vertical reaction sequence in Scheme III.

<sup>†</sup> The two-electron sensitization scheme has recently been described in detail in a paper in press in the *Journal of the American Chemical Society*.

The first process is the same as in conventional sensitization, excitation of a sensitizing dye resulting in electron transfer to the silver halide. In this case, however, an electron donor compound X–Y is added which is lower in oxidation potential than the dye, and is oxidized by the sensitizing dye to form the X–Y radical cation, X–Y<sup>•+</sup>. If

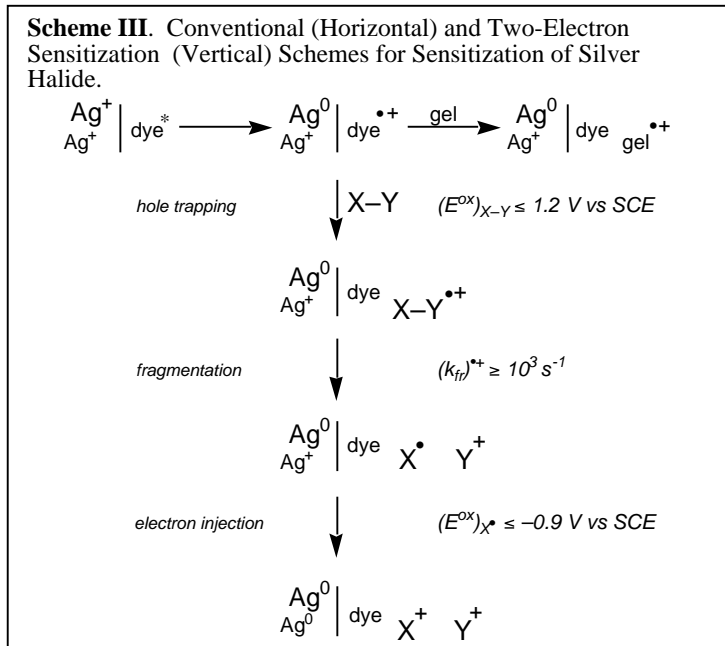

the X–Y<sup>•+</sup> is sufficiently removed from the silver halide grain, then return electron transfer from the silver halide will presumably be slowed. This is unlikely to be particularly beneficial, however, since in photographic systems, return electron transfer could in principle occur on many timescales from less than nanoseconds to even months! Much more beneficial will be the second step, which is irreversible fragmentation of the X–Y bond in the radical cation to generate a radical X<sup>•</sup> and a cation Y<sup>+</sup>. The cation Y<sup>+</sup> is chosen to be sufficiently stable that return electron transfer is thermodynamically unfavorable, and can thus be essentially eliminated. The

most important step is the third. If the radical X<sup>•</sup> is sufficiently reducing, then it can donate a second electron to the silver halide crystal. In this way, *two* electrons can be injected for *each* photon that is absorbed. Formally, the energy of the photon is used to transfer the two electrons of the covalent bond on the X–Y molecule, Eq 1.

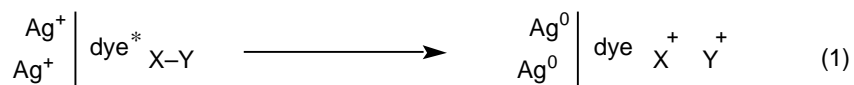

In order for the TES scheme to work properly, the X–Y molecule must satisfy three requirements, as indicated in Scheme III. First, the X–Y must transfer an electron to the oxidized dye. The oxidation potentials of most sensitizing dyes are around 1.4 - 1.2 V vs SCE. Thus this requirement is easily met by having an X–Y with an oxidation potential, (E<sup>ox</sup>)<sub>X–Y</sub>, less than ca. 1.2 V vs SCE. The second requirement is that the X–Y<sup>•+</sup> undergo fragmentation with a rate constant, (k<sub>fr</sub>)<sup>•+</sup>, that is faster than that for return electron transfer, and is preferably controllable. A large number of fragmentation reactions of radical cations have been reported with a range of rate constants, and so this is not considered to be a particular difficulty. The specific fragmentation reactions that have been studied for TES are discussed further below. The third requirement is that the radical X<sup>•</sup> be capable of injecting an electron into the conduction band of the silver halide. This means that the SOMO of the radical must be higher in energy than the silver halide CB, i.e., that the radical must have an oxidation potential, (E<sup>ox</sup>)<sub>X<sup>•</sup></sub>, equal to or more negative than ca. -0.9 V versus SCE (see above). This is clearly the most difficult requirement.

Literature data on the oxidation potentials of organic radicals indicate that –amino radicals have

sufficiently negative oxidation potentials, since oxidation in this case results in formation of a stable iminium salt, Eq 2.<sup>†</sup> Thus, the X–Y compounds should preferably be amines. Furthermore, so that they are not protonated at the pH of the mainly aqueous gelatin environment of the film, the amines should be aromatic. Finally, to be useful in the preparation of photographic films, the compounds also have to be water-soluble. In addition to compounds that

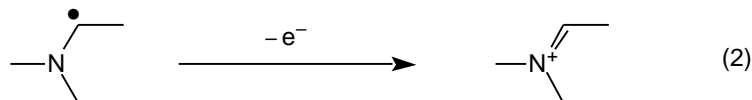

generate radicals - to nitrogen, we have also investigated compounds in which the radicals are conjugated to nitrogen via vinyl or phenyl groups, Scheme IV.

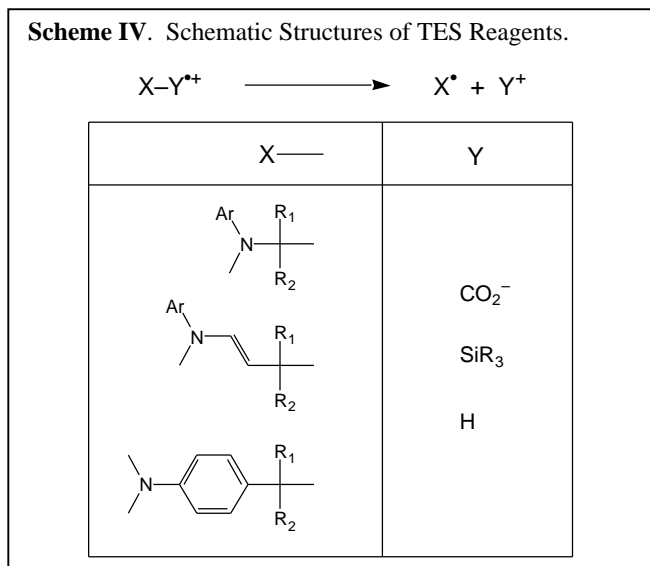

Several fragmentation reactions of amine radical cations have been reported in the literature.<sup>†</sup> Those we have studied for TES reagents include decarboxylation, desilylation and deprotonation, as indicated in Scheme IV. Control of the fragmentation rate is a critical issue. If fragmentation is not fast enough then it will not compete with return electron transfer. If fragmentation is too fast, the TES compound may be unstable towards thermal oxidation. The gelatin medium contains a large and potentially variable amount of water, and although there is a considerable literature related to the kinetics of radical cation fragmentation, there is very little known regarding the effect of water on these processes. We have found that in general, the

different fragmentation reactions respond to water in different ways. Work at Kodak showed that decarboxylation tends to decrease in rate with increasing water concentration, due to an increase in oxidation potential of the carboxylate group in water. Work in the Center for Photoinduced Charge Transfer at the University of Rochester demonstrated that desilylation is nucleophile assisted, with water as a valid nucleophile. Indeed, we find that desilylation of appropriately substituted amine radical cations increases in rate with increasing water content. As yet unpublished work in the Rochester Center showed that deprotonation of aryl amine radical cations can be controlled using stereoelectronic effects, and work at Kodak showed that deprotonation can be induced intramolecularly using a covalently linked base. For the kinds of aromatic amine radical cations indicated in Scheme IV, decarboxylation tends to be the fastest fragmentation reaction, followed by desilylation, with deprotonation being the slowest for the structures studied so far.

<sup>†</sup> See, for example Griller, D.; Wayner, D. D. M. *Pure Appl. Chem.* **1989**, *61*, 717.

<sup>†</sup> For examples that are closely related to the reactions discussed here, see Yoon, U. C.; Mariano, P. S.; Givens, R. S.; Atwater, B. W. *Adv. Electron Transfer Chem.* **1994**, *4*, 117.

Although the rates of the different fragmentation processes depend upon the medium, particularly the amount of water, it is possible to rationally control the reaction via changes to the molecular structure. The decarboxylation reactions provide a nice example. The rate of formation of the radicals should presumably

**Table I.** Rate Constants for Decarboxylation of Amine Radical Cations. The Dashed Lines Indicate the Bonds Which Undergo Fragmentation.

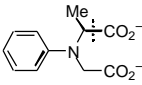
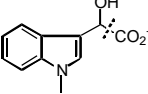
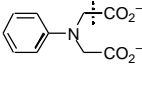
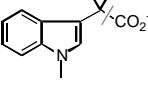
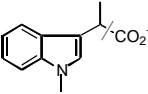
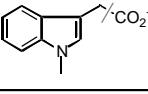
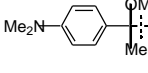
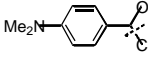
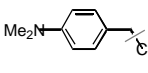
$k_{-CO_2}$ ( $10^7$ s $^{-1}$ )		CH <sub>3</sub> CN / H <sub>2</sub> O (4:1) 22°C	
	> 10		> 30
	1.8		21
			6.5
			2.3
			0.07
			0.05
			0.004

become faster with increasing stability of the radical product. This is clearly observed in the data of Table I. In the indole series, the rate constant for decarboxylation increases as the substitution at the radical center increases from 1<sup>Y</sup> to 2<sup>Y</sup> to 3<sup>Y</sup>. Fragmentation is even faster when the radical is stabilized by an  $\alpha$ -heteroatom, oxygen in this case. Similar effects are observed in the other compounds of Table I. Large differences in the rate constants are also observed between the different structure types. This is presumably mainly due to differences in their oxidation potentials. In general, radical cations of compounds with high oxidation potentials tend to be more reactive than those of compounds with low oxidation potentials. Indoles are harder to oxidize than dimethylanilines, consistent with the observed rate data. By changing oxidation potential and radical stability, the rate constant for fragmentation can be easily changed by more than four orders of magnitude.

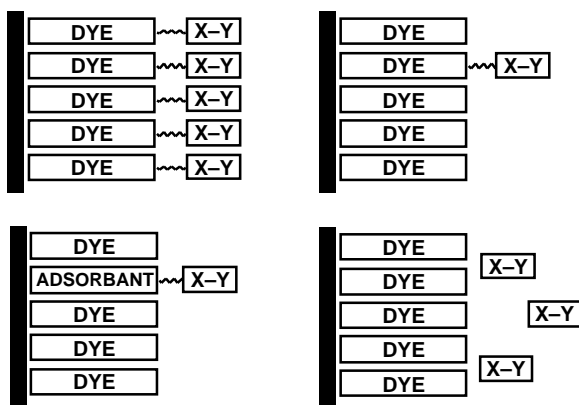

**Scheme V.** Schematic Illustration of Possible Methods for Interaction of X-Y Molecule with the Silver Halide Crystal.

For the TES X-Y molecule to be effective, it should be physically located close to the silver halide surface, so that it can both reduce the oxidized dye and also inject the second electron. There are several ways of bringing the X-Y molecule to the crystal surface, as illustrated in Scheme V. The X-Y molecule can be covalently attached to each dye molecule. Electron transfer between moieties separated by a few atoms has been shown to be quite efficient and can occur in picoseconds. Trapping of the oxidized dye should occur with very high efficiency under these conditions. In another scheme, the X-Y molecule is attached to only a few of the dye molecules. In this case, the "hole" on the

oxidized dye should migrate from dye to dye until it arrives at the one with the X-Y molecule attached. At this point, rapid electron transfer from X-Y to this oxidized dye would occur. This scheme has the advantage that most of the sensitizing dyes are "conventional", and need not be subject to the synthetic procedure required for the linked molecules. Additionally, less disruption of dye aggregation by the attached X-Y groups may occur. Also, because it would be present in sufficiently low concentrations, the dye to which the X-Y is linked need not be identical to the other sensitizing dyes. For example, it could have a slightly lower oxidation potential so that it could effectively "trap" the positive charge of the oxidized dye before being reduced by the X-Y. In a third scheme, the X-Y is covalently attached to a compound that adsorbs to the surface of the silver halide crystal. This scheme also relies on hole hopping, but has the advantage that the X-Y compound is not attached to a light absorbing dye molecule. Finally, the X-Y molecule can simply be added at relatively high concentration, with the assumption that the molecule itself will adsorb sufficiently to the surface of the silver halide, or that it will be present at a sufficiently high concentration so that electron transfer to the oxidized dye can take place. Examples of different modes of interaction as illustrated in Scheme V have been demonstrated, and are described in the patent literature.

**IV. Summary.** A new concept for spectral sensitization of silver halide has been described, two-electron sensitization, which has the capability of delivering two conduction band electrons per absorbed photon. The two-electron sensitization scheme uses an organic electron donating compound X-Y that reacts with the oxidized sensitizing dye, which is formed upon initial photoinduced electron transfer to the silver halide. Useful implementation of the TES scheme relies on careful control of the reactivity of the organic radical cations

**V. Acknowledgements.** The idea for the two-electron sensitization scheme can be traced back to an informal one-day mini-symposium at Columbia University organized by Nick Turro. One of the speakers was David Griller, then of the National Research Council of Canada, who discussed a new method for the determination of the redox potentials of organic radicals, and who brought to our attention the powerful reducing ability of  $\alpha$ -amino radicals.

The concept was later developed at the Eastman Kodak Company by a team of synthetic, physical organic and photochemists in collaboration with photographic scientists, the most important members being Jerry Lenhard, Annabel Muentner, Steve Godleski and Paul Zielinski. The project also relied on fundamental studies of radical cation chemistry described in the literature by many of our organic photochemistry colleagues. Particularly useful was new radical cation chemistry developed at the NSF Center for Photoinduced Charge Transfer at the University of Rochester. We acknowledge wonderfully productive collaborations with Joe Dinnocenzo, Josh Goodman, and David Whitten, then of the University of Rochester, and with postdoctoral fellows Gary Dombrowski, William Todd and Kevin Dockery.

## The Photochemistry of Heteroaromatic Compounds

**James W. Pavlik**  
**Department of Chemistry and Biochemistry**  
**Worcester Polytechnic Institute**  
**Worcester, MA 01609**

The photochemistry of aromatic compounds occupies a central position in the historic development of organic photochemistry. The original discovery by Bryce-Smith and Blair that irradiation of benzene results in the formation of fulvene<sup>1</sup> ushered in an intense period of research in a variety of areas of benzene photochemistry. These studies led to the detection and isolation of the valence isomers of benzene<sup>2-5</sup> and alkyl substituted benzenes,<sup>6-9</sup> the discovery of various photochemically induced cyclo and acyclic addition reactions with benzene, including the synthetically important meta-cycloaddition reaction,<sup>9-11</sup> and the discovery of a large variety of photochemically induced transposition reactions.<sup>12-16</sup> Despite the maturity of these areas, the photochemistry of benzene and its simple derivatives continues to attract the attention of both experimentalists<sup>17-20</sup> and theoreticians.<sup>21</sup>

Work in our laboratory has focused on the photochemistry of heteroaromatic compounds and has led to the discovery of numerous photochemical pathways including phototranspositions, photo-ring contractions, photofragmentations, photocleavage reactions, and photo-ring expansion reactions.

The photochemistry of 4-hydroxypyrylium cations 1 illustrates several of these pathways. Extensive labeling experiments revealed that in concentrated sulfuric acid 4-hydroxypyrylium cations 1 photoisomerize to 2-hydroxypyrylium cations 2a and 2b by the two transposition pathways shown in Scheme 1. These pathways were suggested to be initiated by 2,6- and 2,5-bridging, respectively, in the photochemically excited aromatic cation.<sup>22-26</sup>

Although the transposition patterns have been well established, the electronic details remain a matter of speculation. The suggested primary products, i.e., the oxabicyclohexenyl cation 1a and Dewar-pyrylium cation 1b, are structurally analogous to prevalene and Dewar-benzene formed by initial population of the S<sub>1</sub> and S<sub>2</sub> states of benzene respectively. A similar explanation might account for the formation of the 2,6- and 2,5-bridging in pyrylium cations.

## Scheme 1

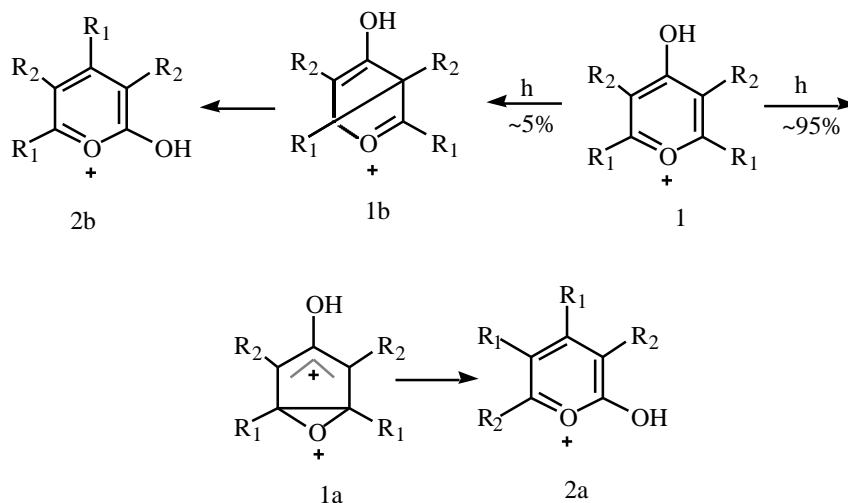

In dilute aqueous sulfuric acid these 4-hydroxypyrylium cations 1 react (Scheme 2) primarily or exclusively by a ring contraction pathway leading to the formation of dihydroxycyclopentenones 3 which can be isolated in synthetically useful yields if the photolysis and neutralization are carried out at 0°C.<sup>27,28</sup> If the irradiated solutions are allowed to warm to room temperature prior to neutralization, the dihydroxycyclopentenones 3 undergo acid-catalyzed isomerization to furyl ketones 4. Alternatively, the photo-ring contraction – thermal isomerization process can be carried out in one step if the irradiation and neutralization are carried out at room temperature.

## Scheme 2

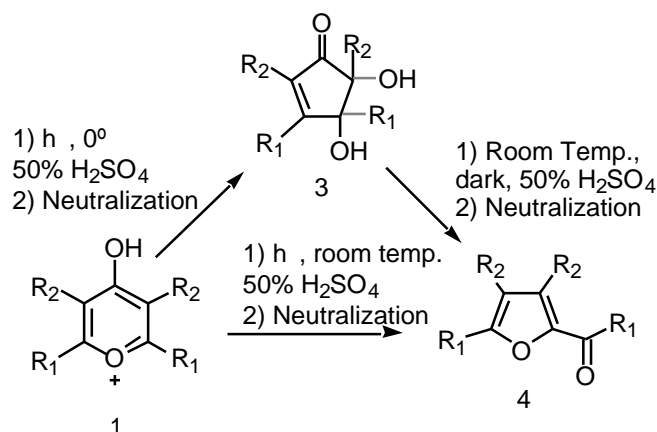

As shown in Scheme 3, 4-pyrones 5 exhibit similar photochemical reactivity. In non-nucleophilic H-bonding solvents, such as 2,2,2-trifluoroethanol (TFE), irradiation results primarily in transposition leading to the formation of 2-pyrones 6.<sup>23,29</sup> Irradiation in more nucleophilic solvents, such as methanol or water, results primarily in the

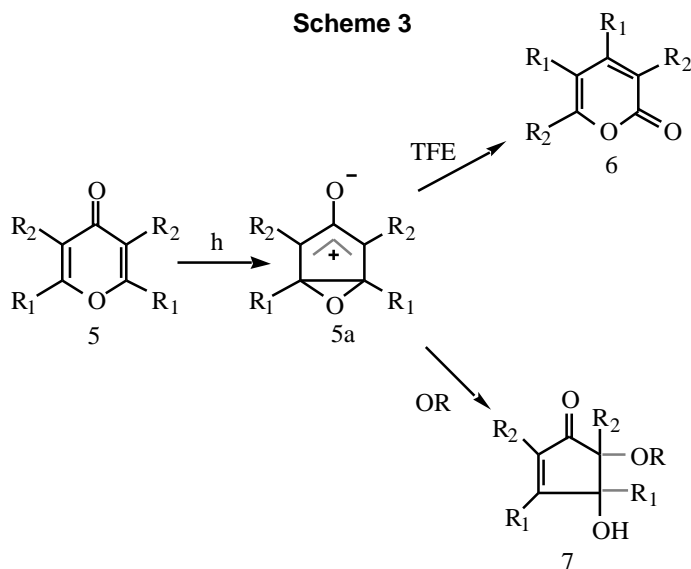

formation of 4-hydroxycyclopentenone solvent adducts 7 formed by intermolecular nucleophilic trapping of the photochemically generated oxabicyclohexenyl cation 5a.<sup>30-32</sup> These reactions have been shown to exhibit a high degree of regio and stereoselectivity. Thus, unsymmetrically substituted 4-pyrones undergo nucleophilic attack mainly at the more highly substituted side of the oxyallyl system and results in the formation of the trans-adduct indicating that the nucleophile adds *anti* to the epoxide ring.<sup>33</sup> Accordingly, the photoreaction of a planar, achiral heterocycle and an inexpensive alcohol yield a functionalized carbocyclic product in diastereoselective fashion. Intra- and inter-molecular variations of this reaction have been further developed and shown to be of considerable synthetic application.<sup>34</sup>

Some years ago, work with Wilzback and Kaplan of the Argonne Photochemistry Group showed that N-methylpyridinium chloride 8 (Scheme 4) undergoes photohydration to yield 6-methylazabicyclo[3.1.0]-hex-3-en-2-ol 9.

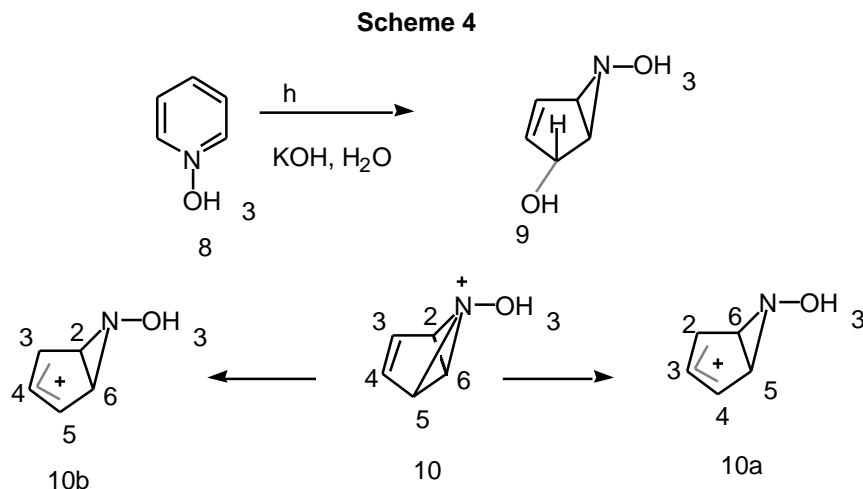

Although this product appeared to result from formation and solvation of an azabicyclohexenyl cation, labeling experiments revealed that in some cases 1,2-shifts of nitrogen precede nucleophilic capture of the bicyclic cation.

These shifts are consistent with formation and statistical opening of a 1-methylazoniabenzvalene 10 resulting in the formation of the unrearranged and rearranged azabicyclohexenyl cations 10a and 10b which are both captured by water.<sup>35</sup> These results showed that the photohydration of the pyridinium ion is completely different from that of pyridine which is converted to an open-chain aminoaldehyde by hydration of the photochemically generated Dewar-pyridine.<sup>36,37</sup> In contrast, the photohydration of N-methylpyridinium ion resembles that of benzene, in which hydration of the initially formed benzvalene yields bicyclo[3.1.0]-en-2-exo-ol.<sup>38-41</sup>

In addition to the mechanistic insights provided by these reactions, the bicyclic products have several interesting features. Both the N-alkyl group and the OH group adopt the exo orientation with respect to the bicyclic skeleton. Furthermore, the photochemical step fixes the relative configuration of the three new stereogenic carbon atoms. It is now recognized that the photohydration of N-substituted pyridinium cations provides a powerful approach to a variety of synthetically useful materials.<sup>42-46</sup>

Although in condensed media pyridine undergoes mainly photovallence isomerization to Dewar-pyridine, irradiation of the six dimethylpyridines at 254 nm in the vapor phase results in phototransposition and photodemethylation or, in one case, photomethylation of a dimethylpyridine to a trimethylpyridine.<sup>47</sup>

Based on the major transposition products observed, as shown in Scheme 5, the six dimethylpyridines can be divided into two triads. The first triad consists of 2,4-dimethyl-11, 2,5-dimethyl-12, and 3,5-dimethylpyridine 13

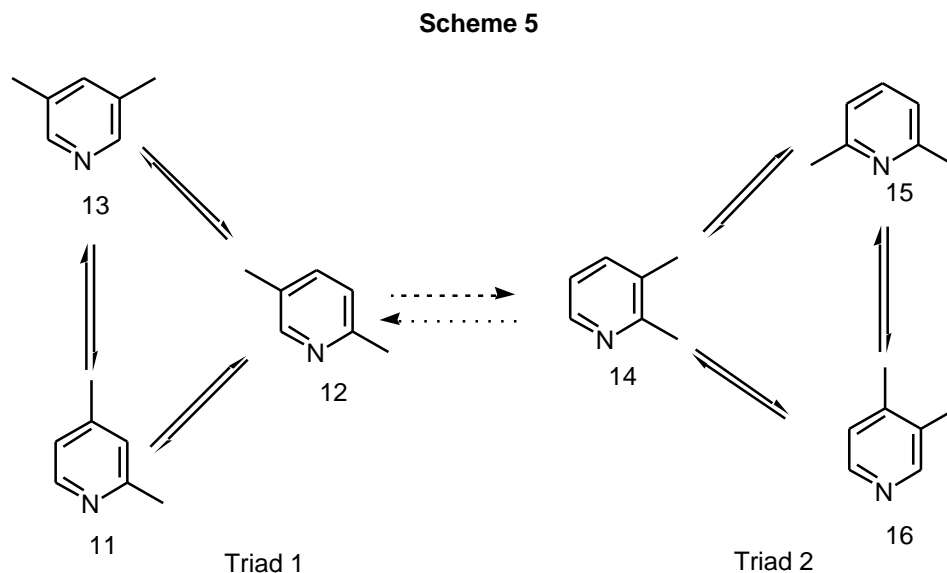

while the second triad includes 2,3-dimethyl-14, 2,6-dimethyl-15, and 3,4-dimethylpyridine 16. Interconversion of the three members of each triad results in the major phototransposition products observed. These intra-triad interconversions were suggested to occur (Scheme 6) *via* 2,6-bonding, originating in a vibrationally excited  $S_2( , *)$  state of the dimethylpyridine, followed by nitrogen migration and rearomatization. This allows nitrogen to insert within each carbon-carbon-bond.

## Scheme 6

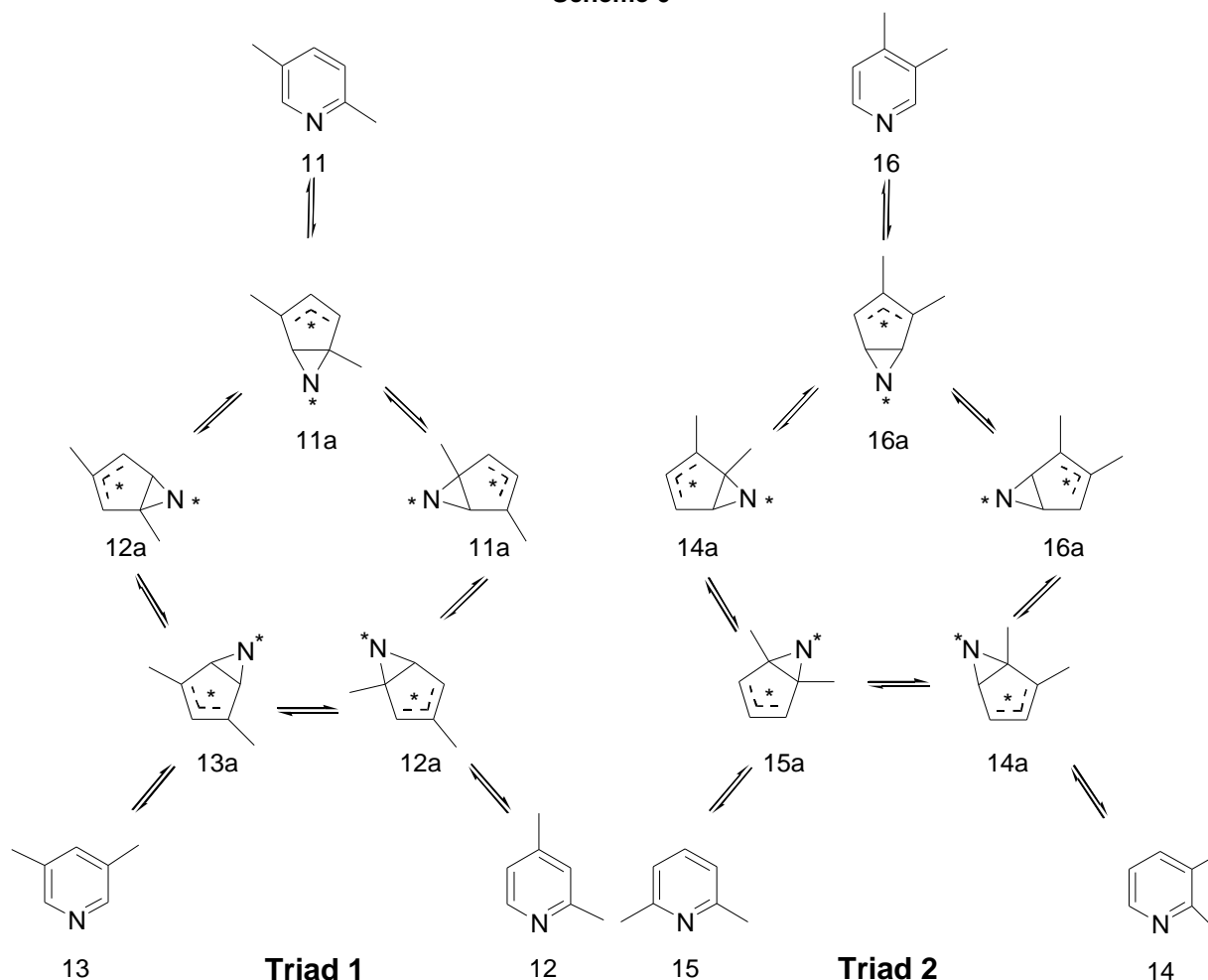

In addition to these intra-triad reactions, 2,5-dimethylpyridine 11, a member of triad 1, was observed to interconvert with 2,3-dimethylpyridine 14, a member of triad 2 (Scheme 5). As shown in Scheme 7, these inter-triad interconversions were shown to occur *via* interconverting Dewar-pyridine intermediates which were detected by  $^1\text{H-NMR}$  spectroscopy after irradiation of the dimethylpyridines in  $\text{CD}_3\text{CN}$  at  $-30^\circ\text{C}$ . These inter-triad

## Scheme 7

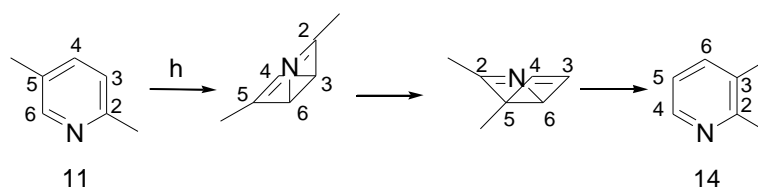

reactions involving Dewar-pyridine intermediates were enhanced by dilution of the dimethylpyridine vapor with nitrogen, by irradiation with light of wavelength  $> 290\text{ nm}$ , and took place in condensed phase at low temperature. This indicates that Dewar-pyridine formation occurs from an excited state of lower energy than the first excited

singlet ( $S_1$ , \*) state. Although this reaction was suggested to result from the triplet state of the dimethylpyridine, this is open to speculation and requires additional research. It is interesting to note, however, that in the case of benzene, Dewar-benzene formation requires excitation to a state of higher energy, i.e.,  $S_2$ ( $S_2$ , \*), while in the case of pyridine and the dimethyl derivatives, the reaction is enhanced by population of an excited state that is of lower energy than the first excited singlet ( $S_1$ , \*) state.

Pincock and colleagues have recently studied the phototransposition chemistry of the six dimethylbenzonitriles in acetonitrile solution. Interestingly, based on their phototransposition products, these compounds can also be divided into two interconverting triads.<sup>19</sup> Furthermore, as in the case of the dimethylpyridines, one triad is comprised of the 2,4-, 2,5, and 3,5-dimethylisomers while the second triad is composed of the 2,3-, 3,4, and 2,6-dimethylisomers. It is significant, however, that inter-triad interconversions were not observed upon irradiation of these compounds which lack the lower-lying  $n, \pi^*$  states available in the pyridine derivatives.

The photochemistry of the five-membered ring heteroaromatic pyrazoles and isothiazoles has occupied much of our attention during the past several years. Several studies of these two classes of compounds had already been published by the time that our work was initiated and based on those studies, it was generally concluded that the photochemical properties of isothiazoles and pyrazoles are quite different. Today we understand that the reactivity of both classes of compounds can be explained by a single general mechanistic scheme.

Although the photoisomerization of N-methylpyrazole to N-methylimidazole (Scheme 8, reaction 1) is formally a simple transformation, extensive labeling experiments have revealed that this takes place by three different transposition patterns which we have labeled  $P_4$ ,  $P_6$ , and  $P_7$  respectively (Scheme 8, reaction 2).<sup>48-50</sup> Isothiazoles phototranspose to thiazoles by the same three patterns (Scheme 8, reaction 3) and also by an addition  $P_5$  transposition pathway that leads to an isomeric isothiazole.<sup>51,52</sup> This  $P_5$  transposition pattern has not been observed in pyrazole photochemistry.

## Scheme 8

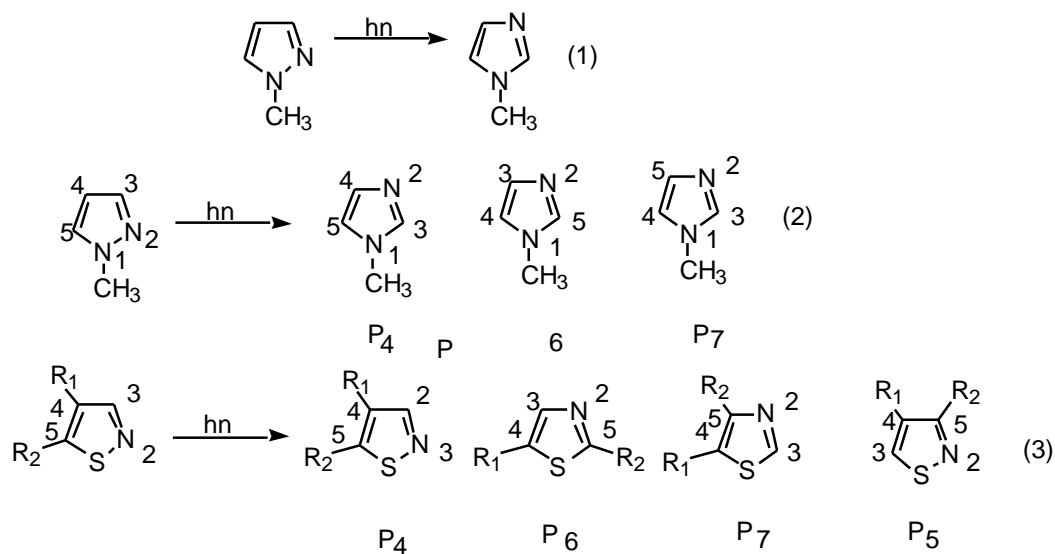

Although the P<sub>5</sub>, P<sub>6</sub> and P<sub>7</sub> pathways involve the largest number of atom interchanges, the formation of all of these products can be explained by the relatively simple mechanistic pathway (Scheme 9) which is again initiated by electrocyclic ring closure. For an N-methylpyrazole, this ring closure results in the formation of a 1,5-

## Scheme 9

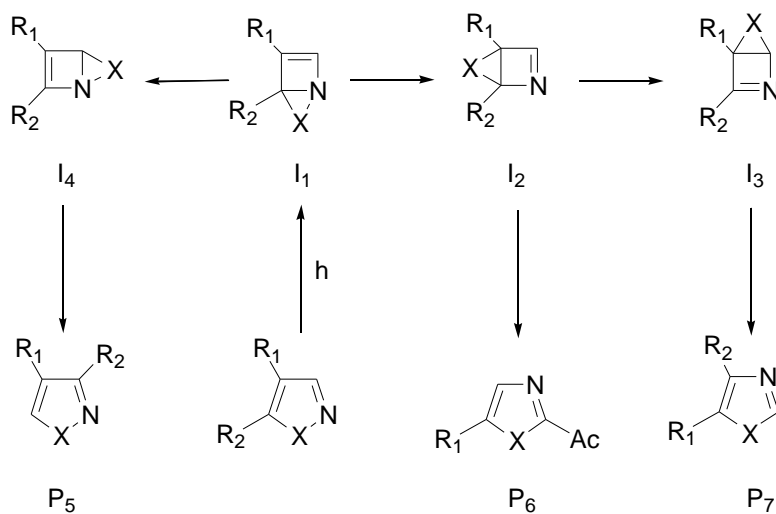

( Pyrazole and Imidazole , X = N-CH<sub>3</sub> ; Isothiazole and Thiazole , X = S )

diazabicyclo[2.1.0]pentene intermediate, I<sub>1</sub> (X=N-CH<sub>3</sub>). In the case of 1-methyl-5-phenylpyrazole, the intermediacy of such a species has been confirmed by trapping a photochemically generated 1,5-diazabicyclic species as a Diels-Alder adduct when the pyrazole was irradiated in furan solvent.<sup>53</sup> In the absence of a trapping agent, electrocyclic ring closure is followed by heteroatom migration. Since only pyrazole to imidazole

transpositions have been observed, two successive [1,3]-sigmatropic shifts of nitrogen must take place regiospecifically away from the azetine nitrogen to form the isomeric 2,5-diazabicyclo[2.1.0]pentene intermediates  $I_2$  and  $I_3$  ( $X=N-CH_3$ ), which rearomatize to the  $P_6$  and  $P_7$  imidazoles respectively, but not in the opposite direction toward the azetine nitrogen since migration in this direction would yield an isomeric 1,5-diazabicyclic species  $I_4$  ( $X=N-CH_3$ ) and eventually a pyrazole to pyrazole transformation.

Phenylisothiazoles also transpose by the electrocyclic ring closure – heteroatom migration mechanism (Scheme 9) but yield an isomeric isothiazole by a  $P_5$  pathway as well as two isomeric thiazoles by the  $P_6$  and  $P_7$  pathways.<sup>52</sup> In the case of phenylisothiazoles, heteroatom migration in the initially formed 1-aza-5-thiabicyclopentene  $I_1$  ( $X=S$ ) must occur in both directions allowing sulfur to migrate around all four sides of the azetine ring. Thus, sulfur walk followed by rearomatization allows sulfur insertion into all four different sites in the carbon-nitrogen sequence and to the formation of  $P_5$ ,  $P_6$ , and  $P_7$  phototransposition products.

The observation of a  $P_5$  transposition product in phenylisothiazole photochemistry, which is not observed in pyrazole photochemistry, does constitute one difference in the reactivity of the two classes of heteroaromatic compounds. The regiospecificity of the pyrazole phototransposition could be because of the greater stability of a 2,5-diazabicyclopentene  $I_2$  relative to a 1,5-diazabicyclopentene  $I_1$  due to the greater strength of the C-N bond in the 2,5-isomer relative to the N-N bond in the 1,5-diaza species. In the azathiabicyclopentene case, the difference between the S-N and S-C bond strengths is not expected to be as great and is therefore not anticipated to exert such a profound effect on the regiochemistry of the migration.

Although the  $P_4$  phototransposition pathway involves the interchange of fewer ring atoms (i.e.,  $N_2$  and  $C_3$ ) than the  $P_5$ ,  $P_6$ , or  $P_7$  pathways, it is mechanistically more complicated (Scheme 10) involving both photocleavage and photo-ring contraction pathways. Both 4-substituted-1-methylpyrazoles<sup>48,53</sup> and 4-substituted-isothiazoles<sup>55</sup> react exclusively *via* this pathway while the photochemistry of 3- and 5-substituted-isothiazoles involves a competition between this pathway and the electrocyclic ring closure-heteroatom migration mechanism.<sup>56</sup>

As shown in Scheme 10, this pathway is initiated by cleavage of the N-N or S-N bond in the heteroaromatic reactant resulting in the formation of a species  $I_1$  that can be viewed as a -N-methyliminovinyl nitrene ( $X=N-CH_3$ ) or as a -thioformylvinyl nitrene ( $X=S$ ). Vinyl nitrenes are known to rearrange to nitriles. Therefore, as expected, irradiation of 4-substituted-1-methylpyrazoles 17( $X=N-CH_3$ ) results in the formation of substituted enamionitriles

## Scheme 10

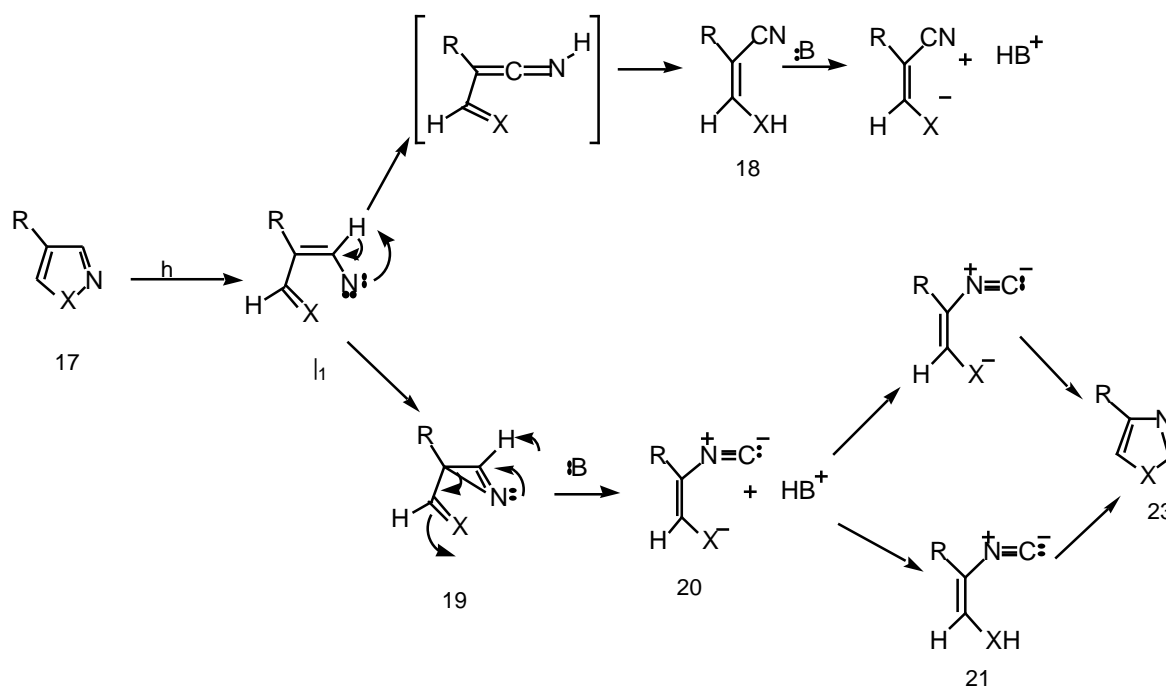

(Pyrazole and Imidazole, X = N-CH<sub>3</sub>; Isothiazole and Thiazole, X = S)

18(X=N-CH<sub>3</sub>) which can be isolated and shown to undergo subsequent (E) → (Z) photoisomerization and inefficient photocyclization to the substituted-1-methylimidazole with interchange of only the N<sub>2</sub> and C<sub>3</sub> atoms as required by the P<sub>4</sub> transposition pathway.<sup>48,53</sup> Since the photocyclization of 18 is inefficient, the pyrazole enaminonitrile → imidazole pathway is not a major pathway for the P<sub>4</sub> phototransposition. Similarly, 4-substituted isothiazoles also undergo this photocleavage pathway to yield substituted cyanosulfides 18(X=S) which can be trapped and characterized as their benzyl thioether derivatives.<sup>55</sup>

Vinyl nitrenes are also known to be in equilibrium with their isomeric azirines. -Thioformylvinyl nitrene I<sub>1</sub>(X=S), formed from 4-substituted isothiazoles 17(X=S), would therefore be in equilibrium with the substituted thioformylazirines 19(X=S). In the presence of an external base (triethylamine, NH<sub>3</sub>, aqueous NaHCO<sub>3</sub>), it is suggested that the azirine 19 undergoes deprotonation by the added base resulting in the formation of an isocyanide sulfide 20 and the protonated base.

In the case of substituted N-methylpyrazoles 17(X=N-CH<sub>3</sub>), an added external bases is not necessary, presumably because the pyrazole or imidazole is sufficiently basic to deprotonate the azirine. Reprotonation of the isocyanide at the more basic amide nitrogen thus provides the observed enaminoisocyanide 21(X=N-CH<sub>3</sub>). In the case of 1-methyl-4-phenylpyrazole 17(X=N-CH<sub>3</sub>) the resulting enaminoisocyanide 21(X=N-CH<sub>3</sub>) is sufficiently stable to be isolated and fully characterized and shown to undergo efficient photochemical and thermal cyclization to 1-methyl-4-phenylimidazole 23(X=N-CH<sub>3</sub>), the P<sub>4</sub> product.<sup>53,54</sup> The efficiencies of these reactions shows that the pyrazole → isocyanide → imidazole sequence is a major pathway for the P<sub>4</sub> transposition reaction.

Furthermore, isocyanides were also observed as intermediates in the P<sub>4</sub> phototransposition of a variety of other 4- and 5-substituted-1-methylpyrazoles confirming the generality of this pathway in pyrazole photochemistry.<sup>53</sup>

In the case of 4-substituted isothiazole photochemistry, the fate of the isocyanide depends on the nature of the substituent originally at C-4 of the isothiazole ring. If the substituent is aromatic, the extended conjugation of the sulfide and aryl group lowers the basicity of the sulfide, leaving the isocyanide carbon as the more basic site. The effect of protonation at this position to form 22(X=S) is to render the carbon more susceptible to nucleophilic attack by the negative sulfur. As a result, these substituted isocyanides cyclize spontaneously to the 4-arylthiazoles (23, X=S, R=Aryl) and cannot be detected or chemically trapped.<sup>55</sup>

If the C-4 substituent is alkyl or substituted alkyl, the reduced conjugation raises the energy of the sulfide so that sulfur is more basic. Thus, protonation at this position leads to 21(X=S, R=Alkyl) which reduces the nucleophilic character of the sulfur and also leaves the negatively charged isocyanide carbon less susceptible to nucleophilic attack. As a result, cyclization requires a higher energy of activation, and hence, the alkyl substituted isocyanothiols can be detected spectroscopically and trapped and characterized as their N-formylaminobenzyl thioether derivatives.<sup>55</sup>

**Acknowledgements.** I am pleased to gratefully acknowledge the diligent and dedicated collaboration of the undergraduate and graduate students whose names appear as co-authors in the references.

## References

1. Blair, J.M.; Bryce-Smith, D. *Proc. Chem. Soc.* **1957**, 287; Angus, H.J.F.; Blair J.M.; Bryce-Smith, D. *J. Chem. Soc.* **1960**, 2003.
2. Wilzbach, K.E.; Ritscher, J.S.; Kaplan, L. *J. Am. Chem. Soc.* **1967**, 89, 1031.
3. Kaplan, L.; Wilzbach, K.E. *J. Am. Chem. Soc.* **1968**, 90, 3921.
4. Ward, H.R.; Wishnok, J.S. *J. Am. Chem. Soc.* **1968**, 90, 1086.
5. Bryce-Smith, D.; Gilbert, A.; Robinson, D.A. *Angew. Chem. Int. Ed. Engl.* **1971**, 10, 74.
6. van Tamelen, E.E.; Pappas, S.P. *J. Am. Chem. Soc.* **1962**, 84, 3789.
7. Wilzbach, K.E.; Kaplan, L. *J. Am. Chem. Soc.* **1965**, 4004.
8. Den Bestan, I.E.; Kaplan, L.; Wilzbach, K.E. *J. Am. Chem. Soc.*, **1968**, 90, 5868.
9. Wilzbach, K.E.; Kaplan, L. *J. Am. Chem. Soc.* **1966**, 88, 2066.
10. Bryce-Smith, D.; Gilbert, A.; Orger, B.H. *Chem. Comm.* **1966**, 572.
11. Cornelisse, J. *Chem. Rev.* 93, 615.
12. Wilzbach, K.E.; Kaplan, L. *J. Am. Chem. Soc.* **1964**, 86 2307.
13. Burgstahler, A.W.; Chien, P-L. *J. Am. Chem. Soc.* **1964**, 86, 2940.
14. Burgstahler, A.W.; Chien, P-L. *J. Am. Chem. Soc.* **1964**, 86, 5281.
15. Arnett, E.M.; Bollinger, J.M. *Tetrahedron Lett.*, **1964**, 3803.
16. Kaplan, L.; Wilzbach, K.E.; Brown, W.G.; Yang, S.S. *J. Am. Chem. Soc.* **1965**, 87, 675.
17. MacLead, P.J.; Pincock, A.L.; Pincock, J.A.; Thompson, K.A. *J. Am. Chem. Soc.* **1998**, 120, 6443.
18. Foster, J.; Pincock, A.L.; Pincock, J.A.; Thompson, K.A. *J. Am. Chem. Soc.* **1998**, 120, 13354.
19. Howell, H.; Pincock, J.A.; Stefanova, R. *J. Org. Chem.* **2000**, 65, 6173.
20. Pincock, A.L.; Pincock, J.A.; Rifai, S.; Thompson, K.A. *Can. J. Chem.* **2000**, 78, 1019.
21. Palmer, I.J.; Ragazos, I.N.; Bernardi, F.; Olivucci, U.; Robb, M.A. *J. Am. Chem. Soc.* **1993**, 673.
22. Pavlik, J.W.; Clennan, E.L. *J. Am. Chem. Soc.*, **1973**, 95, 1697.
23. Pavlik J.W.; Kwong, J. *J. Am. Chem. Soc.*, **1973**, 95, 7914.
24. Pavlik, J.W.; Bolin, D.R.; Bradford, K.C.; Anderson, W.G. *J. Am. Chem. Soc.* **1977**, 99, 2816.
25. Pavlik, J.W.; Dunn, R. *Tetrahedron Lett.* 1978, 5071.
26. Pavlik, J.W.; Patten, A.D.; Bolin, D.R.; Bradford, K.C.; Clennan, E.L. *J. Org. Chem.* **1984**, 49, 4523.
27. Pavlik, J.W.; Spada, A.P. *Tetrahedron Lett.* **1979**, 4441.
28. Pavlik, J.W.; Spada, A.P.; Snead, T.E. *J. Org. Chem.* **1985**, 50, 3046.
29. Keil, E.B.; Pavlik, J.W. *J. Heterocyclic Chem.* **1976**, 13, 1149.
30. Pavlik, J.W.; Pauliukonis, L.T. *Tetrahedron Lett.* **1976**, 1939.
31. Pavlik, J.W.; Snead, T.; Tata, J.R. *J. Heterocyclic Chem.* **1981**, 18, 1481.
32. Pavlik, J.W.; Keil, E.B.; Sullivan, E.L. *J. Heterocyclic Chem.* **1992**, 29, 1829.
33. Pavlik, J.W.; Kirincich, S.J.; Pires, R.M. *J. Heterocyclic Chem.* **1991**, 28, 537.
34. See, for example, West, F.G. *Adv. Cycloaddition*, **1997**, 4, 1 and references therein.
35. Kaplan, L.; Pavlik, J.W.; Wilzbach, K.E. *J. Am. Chem. Soc.* **1972**, 94, 3283.
36. Jousot-Dubien, J.; Houdard-Pereyre, J. *Bull. Soc. Chim. Fr.* **1969**, 2619.
37. Wilzbach, K.E.; Rausch, D.J. *J. Am. Chem. Soc.* **1970**, 92, 2178.
38. Farenhorst, E.; Bickel, A.F. *Tetrahedron Lett.* **1966**, 5911.
39. Berson, J.A.; Hasty, N.M., Jr. *J. Am. Chem. Soc.* **1971**, 93, 1549.

40. Katz, T.J.; Wang, E.J.; Acton, N. *J. Am. Chem. Soc.* **1971**, *93*, 3782.
41. Kaplan, L.; Wendling, L.A.; Wilzbach, K.E. *J. Am. Chem. Soc.* **1971**, *93*, 3821.
42. Glarner, F.; Thornton, S.R.; Scharer, D.; Bernardinelli, G.; Burger, U. *Helv. Chim. Acta* **1997**, *80*, 121.
43. Acar, E.A.; Glarner, F.; Burger, U. *Helv. Chim. Acta*, **1998**, *81*, 1095.
44. Ling, R.; Yoshida, M.; Mariano, P.S. *J. Org. Chem.* **1996**, *61*, 4439.
45. Ling, R.; Mariano, P.S. *J. Org. Chem.* **1998**, *63*, 6072.
46. Cho, S.J.; Ling R.; Kim A.; Mariano, P.S. *J. Org. Chem.* **2000**, *65*, 1574.
47. Pavlik, J.W.; Kebede, N.; Thompson, M.; Day, A.C.; Barltrop, J. *Am. Chem. Soc.* **1999**, *121*, 5666.
48. Pavlik, J.W.; Kurzweil, E.M. *J. Org. Chem.* **1991**, *56*, 6313.
49. Connors, R.E.; Pavlik, J.W.; Burns, D.S.; Kurzweil, E.M. *J. Org. Chem.* **1991**, *56*, 6321.
50. Pavlik, J.W.; Connors, R.E.; Burns, D.S.; Kurzweil, E.M. *J. Am. Chem. Soc.* **1993**, *115*, 7654.
51. Pavlik, J.W.; Pandit, C.R.; Samuel, C.J.; Day, A.C. *J. Org. Chem.* **1993**, *58*, 3407.
52. Pavlik, J.W.; Tongcharoensirikul, Bird, N.P.; Day, A.C.; Barltrop, J.A. *J. Am. Chem. Soc.* **1994**, *116*, 2292.
53. Pavlik, J.W.; Kebede, N. *J. Org. Chem.* **1997**, *62*, 8325.
54. Pavlik, J.W.; Kebede, N.; Bird, N.P.; Day, A.C.; Barltrop, J.A. *J. Org. Chem.* **1995**, *60*, 8138.
55. Pavlik, J.W.; Tongcharoensirikul, P.; French, K.M. *J. Org. Chem.* **1998**, *63*, 5592.
56. Pavlik, J.W.; Tongcharoensirikul, P. *J. Org. Chem.* **2000**, *65*, 3626.

## Metal Nanoparticles. How Noble Are They in the Light?

**Prashant V. Kamat**  
**Notre Dame Radiation Laboratory**  
**Notre Dame, Indiana 46556-0579**  
**(Email:pkamat@nd.edu; <http://www.nd.edu/~pkamat>)**

Semiconductor and noble metal clusters in the nanometer size regime display size-dependent optical, electronic and chemical properties (see for example, references [1-8]). Such nanoscale materials have potential applications in developing biological nanosensors and optoelectronic nanodevices [9-11]. A burst of research activity has occurred in recent years in the area of synthesis and characterization of different size and shape of metal nanoparticles. The size-dependent optical properties of metal nanoparticles make an interesting case for photochemists and photobiologists to exploit their role in light-induced chemical reactions.

Noble metals in bulk are photoactive only to a small extent, although photoemission from silver electrodes has been noted by Gerischer and his coworkers [12]. The metal nanoparticles on the other hand exhibit excellent photochemical activity because of their high surface/volume ratio and unusual electronic properties. For example, Henglein and coworkers [13, 14] reported photochemical dissolution of Ag colloids when photoejected electrons were scavenged by species such as  $N_2O$ .

**Ease of Preparing Metal Nanoparticle Suspensions and Nanostructured Films.** Metal colloids can be prepared by the conventional method of reducing a metal salt in aqueous solution. For example, reduction of  $HAuCl_4$  (0.12 mM) in water with sodium citrate at near boiling temperature produces 20-30 nm diameter gold nanoparticles [15]. The method can be conveniently modified to include different stabilizers, supports and/or reductants. A controlled radiolytic reduction method has been proved to be very convenient to prepare metal nanoparticles of desired size [16]. Highly concentrated, organically soluble gold nanoparticles have also been prepared using a biphasic reduction procedure [17-19]. In this methodology,  $H AuCl_4$  dissolved in water is first extracted into the organic phase using a phase-transfer reagent, tetraoctylammonium bromide, and later reduced with the slow addition of  $NaBH_4$  solution. Since these colloids can be dispersed in a variety of solvents (polar as well as nonpolar organic solvents) one can study the interaction between gold nanoparticle and different organic molecules.

Langmuir-Blodgett film or self assembled monolayers [20-25] are quite effective for assembling gold nanoparticles as two-dimensional arrays on an electrode surface. Monodisperse fractions of thiol-stabilized gold nanoparticles have also been crystallized into two- and three-dimensional superlattices [26]. In a recent communication we have described a simple electrophoretic method of casting three-dimensional assemblies of gold nanoparticles on conducting glass electrodes that exhibit strong surface plasmon resonance characteristics [27].

**Chemical Binding of Gold Nanoparticles with Photoactive Molecules.** Engineering of the nanocluster surfaces, with electro- or photoactive molecules, can provide three-dimensional molecular arrangements around the nanoparticles. Researchers have often used functional groups such as thiols, amines, or silanes to attach

electroactive or photoactive molecules to the gold surface [28-32]. These photoactive hybrid nanoparticles have potential applications in designing light energy harvesting devices of nanometric dimension and photocatalysts. The ability of the gold surface to bind with specific functional groups has made it suitable for optoelectronic applications such as fluorescence patterning [33]. Colloidal gold particles adsorb strongly to some proteins, especially antibodies. Colloidal gold functionalized with specific binding groups can be used to label a wide variety of biologically active molecules, such as lipids, oligonucleotides and peptides. Since fluorescence spectroscopy is a very sensitive technique, fluorophore-bound gold nanoparticles are useful probes for biomolecular labeling (e.g., as immunoprobes) [11, 34, 35]. Such an inorganic-organic hybrid probe also offers the possibility of using complementary sensing *via* fluorescence spectroscopy (e.g., confocal microscope) and electron microscopy.

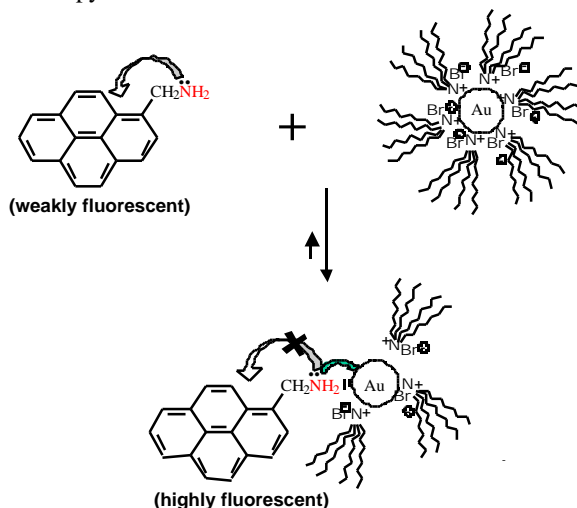

Figure 1. Suppression of intramolecular quenching process of 1-aminomethylpyrene upon binding to gold nanoparticles.(ref.[19])

the amino group to the gold surface, the electron-donating ability of the amine group is decreased and this in turn suppresses the electron transfer from its lone pair to the pyrene moiety. Such inorganic-organic hybrid materials soluble in organic solvents are potentially useful for the fabrication of biological nanosensors, biochemical labeling and optoelectronic nanodevices.

**Plasmon Absorption of Metal Nanoparticles.** Some similarities between metal and semiconductor nanoclusters can be drawn with respect to their physical properties [36]. They are optically transparent and act as dipoles. While conduction and valence bands of semiconductors are separated by a well-defined bandgap, metal nanoclusters have close-lying bands and electrons move quite freely. The free electrons give rise to a surface plasmon absorption band in metal clusters. The frequency, intensity and width of the surface plasmon absorption band is dependent both on the cluster size/shape and the surrounding medium [36-38]. The refractive index of the medium and the chemical species that interact with the metal surface induce optical shifts in the surface plasmon band.

The surface plasmon absorption band of metal nanoclusters is very sensitive to the surface-adsorbed species and dielectric of the medium. For example, chemisorbed  $\Gamma^-$ ,  $\text{SH}^-$  and  $\text{C}_6\text{H}_5\text{S}^-$  ions results in damping of the surface plasmon band of colloidal silver particles [39, 40]. Alternatively, one can also observe bleaching of the surface plasmon band with electrons deposited from radiolytically produced radicals which cause a blue shift and

We have recently succeeded in organizing a fluorophore molecule, 1-aminomethyl pyrene, on gold nanoparticles without inducing such aggregation effects [19]. An increase in the fluorescence yield of the pyrene moiety was observed as the nonradiative decay process was suppressed upon binding to gold nanoparticles (Figure 1). The Py- $\text{CH}_2\text{NH}_2$  molecules in THF are weakly fluorescent since the intramolecular quenching dominates the deactivation of the excited singlet state. The photoinduced electron transfer between the lone pair of the amine and the pyrene moiety competes with the radiative and non-radiative decay of the singlet excited state. Upon binding of

narrowing of the plasmon band [41]. A more detailed discussion on the damping effects caused by surrounding material can be found elsewhere [37, 38, 42].

**Transient bleaching of the surface plasmon band.** The visible absorption bands of the gold (~530 nm) and silver (~380 nm) colloids makes them ideal candidates to probe optical effects using transient absorption spectroscopy. When these metal colloids are excited with a short laser pulse a prompt bleaching of the plasmon band is observed within the laser pulse duration. The difference absorption spectrum of gold colloids shown in

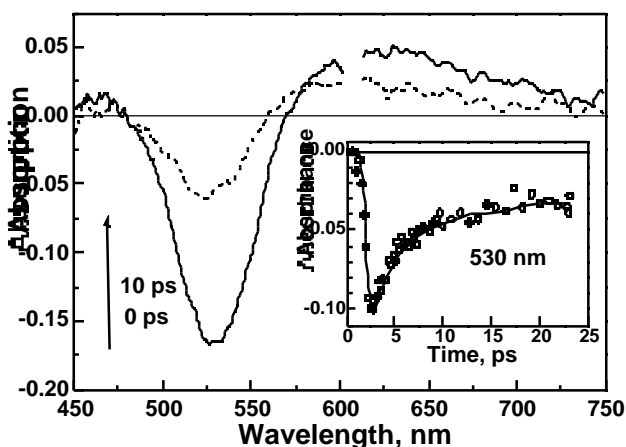

Figure 2. Transient absorption spectra of the colloidal gold sample as a function of the time delay between the pump and probe laser beams. The inset show the kinetics of the plasmon band recovery using 380 nm excitation light. (ref. [43])

Figure 2 exhibits an intense bleaching of the surface plasmon band at 520 nm. The plasmon band of metal particles as explained on the basis of Mie theory involves dipolar oscillations of the free electrons in the conduction band that occupy energy states immediately above the Fermi level [37, 44]. Once these electrons are excited by a laser pulse, they do not oscillate at the same frequency as that of the unexcited electrons, thus resulting in the decrease of the plasmon absorption band. These aspects have been addressed in recent spectroscopic investigations [43, 45, 46]. The recovery of the plasmon

band at the picosecond timescale arises from the electron-phonon and phonon-phonon relaxation.

The bleaching recovery of the pristine Au colloids has been shown to consist of a fast ( $\approx 2.5$  ps) and a slow process ( $>50$  ps) [43]. The slower component of the recovery had a lifetime of 170 ps. These fast and slow recoveries are attributed to the relaxation of "hot" electrons via electron-phonon coupling and phonon-phonon relaxation of the lattice respectively. Dumping thermal energy into the solvent causes the dielectric of the surrounding medium to change, which in turn influences the plasmon resonance frequency of the metal nanoclusters.

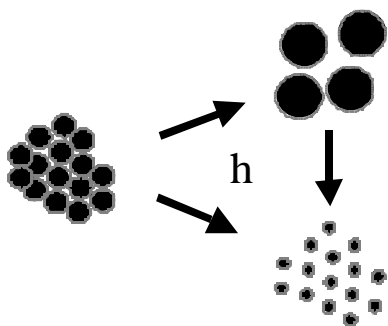
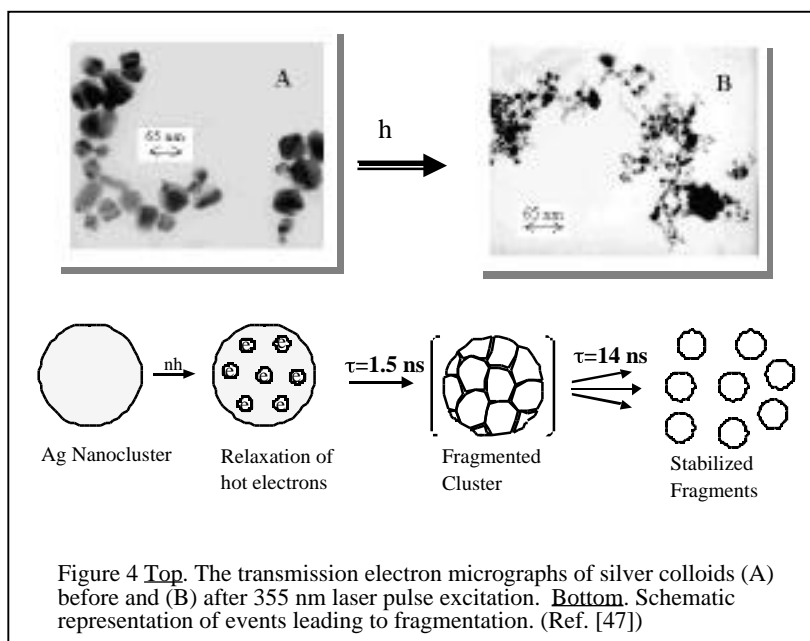

Figure 3. Photoinduced fusion and fragmentation of metal nanoparticles considered to be biphotonic as they dominate at high laser intensities.

**Laser-Induced Morphological Changes.** Silver and gold nanoparticles suspended in water undergo morphological changes under laser irradiation [47, 48]. When metal nanoparticles are dispersed in solution the thermal energy gets dumped into the surrounding solvent. On the other hand, when these particles exist as clustered aggregates, the energy gained from the absorbed photons is dispersed as excess heat into the neighboring particles. Increased temperature of the cluster assembly thus paves the way to the melting of gold nanoparticles to form bigger clusters. These two possibilities are schematically illustrated in Figure 3. These processes are often

**Photofragmentation of Silver Nanoclusters.** The citrate reduction method produces relatively larger-sized silver nanoparticles with diameters ranging from 40-60 nm. The absorption spectrum of the silver colloids



shows a surface plasmon absorption band with a maximum around 420 nm. This absorption band is rather broad and red-shifted compared to the plasmon absorption band of silver colloids prepared by radiolysis and other reduction methods. 355 nm laser pulse excitation of the silver nanoclusters led to a blue shift in the absorption spectrum. The blue shift in the absorption maximum was accompanied by a narrowing of the surface plasmon band and an increase in the magnitude of absorption. The blue shift and increase in the

oscillator strength of the surface plasmon band is indicative of a decrease in particle diameter. Transmission electron micrographs recorded before and after the laser pulse excitation (Figure 4) confirm that the relatively large (40-60 nm) silver particles fragment to produce smaller (~5-10 nm diameter) particles.

The photofragmentation of silver colloids can be probed by time-resolved transient absorption

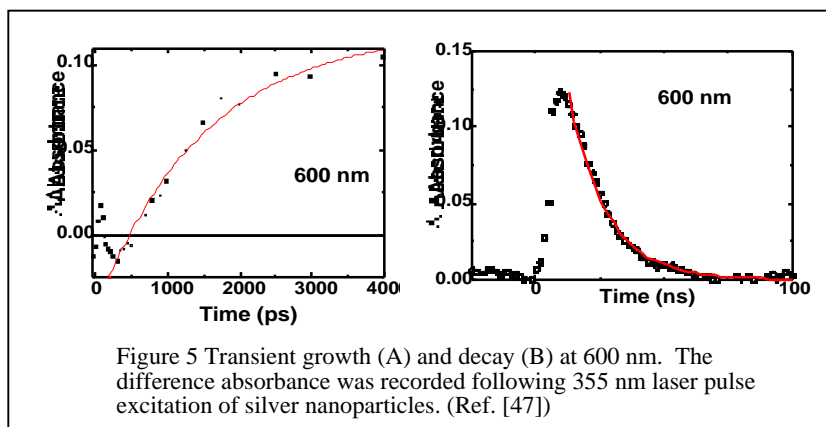

experiments in a picosecond laser flash photolysis apparatus.[47] Transient absorption spectra recorded at early times show transient bleaching at the surface plasmon band (400 nm). However at longer delay times we see an increased absorbance in the red region. As the larger silver clusters become charged with electrons at their surface,

intraparticle changes occur. The intermediate of the fragmentation process which is monitored at 600 nm shows a growth time of 1.5 ns (Figure 5). This transient is essentially an aggregate of smaller clusters that are in close proximity. It is well known that aggregation of small Ag particles leads to a broad plasmon absorption band across the entire visible spectrum [37]. The time constant of 1.5 ns corresponding to the absorption growth in Figure 5A shows the time frame with which chemical and physical changes occur in the parent Ag cluster following the laser pulse excitation. This transient aggregate then dissociates to generate smaller stabilized Ag nanoclusters. The 14.2 ns decay component of the transient absorption at 600 nm (Figure 5B) corresponds to the

time frame in which the fragmented clusters stabilize in solution. These smaller clusters possess properties that are exclusive to smaller particles (e.g., exhibiting a 400 nm plasmon band maximum).

**Photofusion of Thionicotinamide Capped Gold Nanoclusters.** Interaction of thio- compounds with gold nanoclusters in solution often leads to aggregation effects. Such an aggregation is noted by the appearance of

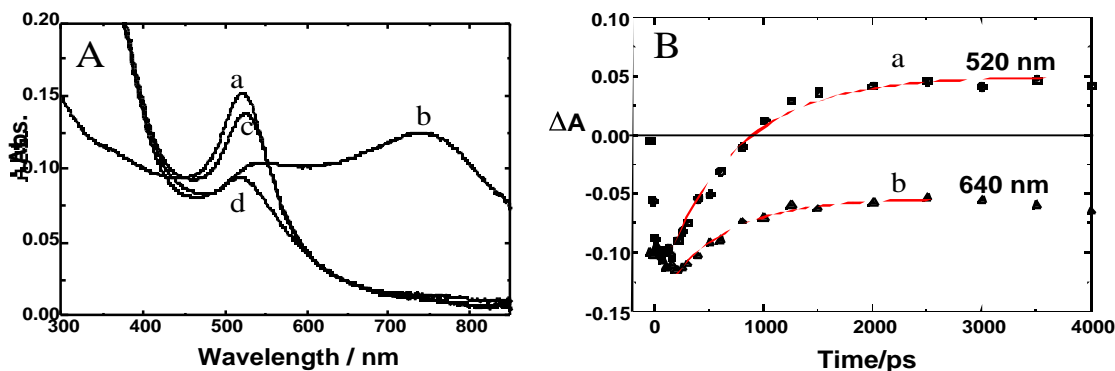

Figure 6. A(a) Absorption spectrum of 0.5 mM gold colloids in water. Absorption spectra of TNA-capped gold colloids (0.5 mM gold colloidal suspension containing 3 mM thionicotinamide) were recorded (b) before irradiation, (c) 1 min and (d) 30 min after 532 nm laser pulse (pulse width 18 ps, 1.5 mJ/pulse) irradiation respectively. B. The absorption-time profiles recorded at (a) 520 nm and (b) 640 nm following the laser pulse (532 nm) irradiation of TNA-capped gold nanoclusters. (Ref. [48])

a broad band in the red-infrared region. For example, the purple colored gold colloidal solution turns blue as we add small amounts of thionicotinamide [48]. Upon laser pulse (532 nm) irradiation of TNA-capped gold nanoparticle suspension for few minutes, we observe a reversal of color change from blue to ruby-red. The broad absorption band at 750 nm disappears during this laser irradiation experiment (spectrum *c* in Figure 6A). Increased absorption at 520 nm associated with the spectral change indicates the restoration of the surface plasmon absorption band. The excitation with 532 nm laser pulse thus prompts the disappearance of aggregation effects in TNA-capped gold nanoparticles.

The morphological changes caused by the laser irradiation were probed for the TNA-capped gold nanoparticle samples using transmission electron microscopy (Figure 7). Native gold colloids prepared by citric acid reduction method are nearly spherical in shape with a particle diameter of 15-20 nm. The transmission electron micrograph of TNA-capped gold nanoparticles (Figure 7A) shows the presence of cluster islands, each consisting of several nanoparticles that are in close contact. The sample taken after one minute laser pulse irradiation (532 nm, 10Hz, 1.5 mJ) shows the formation of large particles that are nearly spherical (Figure 7B). These large size particles, which are well separated from each other, do not exhibit optical transitions (the absorption band in the red-IR region) that correspond to aggregation effects.

Figure 6B shows the absorption-time profiles recorded at 520 nm and 640 nm. The bleaching observed at these two wavelengths occurs within the laser pulse duration of 18 ps. The bleaching at 640 nm recovers partially during the period of 1 ns. The residual bleaching represents the disappearance of the aggregate band. This absorption-time profile at 640 nm also indicates the period within which the aggregates of TNA-capped gold nanoparticles undergo physical changes following laser pulse irradiation. On the other hand 520 nm bleaching which represents the damping of the plasmon band recovers quickly (within 2 ns) and exhibits a residual positive absorption at longer times. The increased (positive) absorbance at 510 nm essentially represents the growth in the plasmon absorption as a result of aggregate breakup. The transmission electron micrographs support the hypothesis that aggregates of TNA-capped nanoclusters undergo fusion to form larger nanoparticles even under

short-term (~1 min) laser irradiation. Although these nanoclusters have grown in size (~100 nm), they are well separated from each other, thus ceasing the aggregation effects on the absorption spectrum. No such changes were seen when unmodified gold colloids were subjected to laser pulse irradiation.

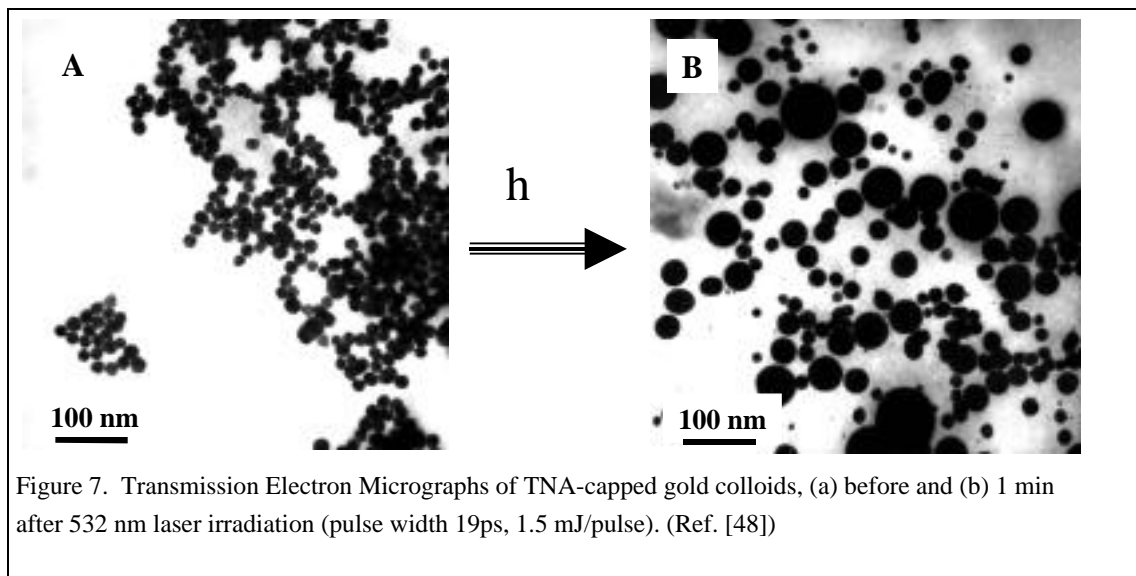

We have attributed the photofusion phenomenon to the melting of aggregates to form larger spherical particles during laser irradiation [48]. Since surface-modified gold nanoparticles exist as aggregates we expect the energy gained from the absorbed photons to be dispersed as excess heat to the neighboring particles, thus inducing their fusion. Similar laser-induced fusion is not seen in uncapped gold colloids because individual particles are well separated and the heat gained from laser excitation is quickly dumped into the surrounding aqueous medium (< 200 ps) [46, 49, 50]. More details on the melting of gold nanoparticles and nanorods under laser pulse irradiation can be found elsewhere [51-54].

In summary, this overview article highlights some photoactive properties of metal nanoclusters. The examples presented here show the feasibility of employing time-resolved transient absorption and emission spectroscopy techniques to probe the laser-induced morphological changes in metal nanoclusters. Basic understanding of these photoprocesses is important for designing metal cluster-based optical nanodevices. Development of semiconductor-metal or metal-sensitizer nanocomposites is likely to play an important role in improving the efficiency of light harvesting systems.

**Acknowledgements.** I would like to acknowledge the scientific contributions from the members of our research group, Drs. K. George Thomas, N. Chandrasekharan, H. Fujiwara, Ms. A. Dawson, Ms. B. Shanghavi and Mr. M. Flumiani, which have been highlighted in this article. The work described herein was supported by the Office of the Basic Energy Sciences of the U.S. Department of Energy. This is contribution No. NDRL4276 from the Notre Dame Radiation Laboratory. All figures have been reproduced with the permission of the American Chemical Society.

## References.

1. Henglein, A., "Physicochemical properties of small metal particles in solution: "Microelectrode" reactions, chemisorption, composite metal particles, and the atom-to-metal transition",. *J. Phys. Chem.*, **1993**. 97(21), 5457-71.
2. Mulvaney, P.; Giersig, M.; Henglein, A., "Electrochemistry of multilayer colloids: Preparation and absorption spectrum of gold-coated silver particles",. *J. Phys. Chem.*, **1993**. 97(27), 7061-7064.
3. Wang, Y. ; Herron, N., "X-ray photoconductive nanocomposites",. *Science*, **1996**. 273(5275), 632-634.
4. Kamat, P.V., "*Composite Semiconductor Nanoclusters*", in "*Composite Semiconductor Nanoclusters*", P.V. Kamat and D. Meisel, Editors. **1997**, Elsevier Science: Amsterdam. p. 237-259.
5. Nirmal, M.; Dabbousi, B.O.; Bawendi, M.G.; Macklin, J.J.; Trautman, J.K.; Harris, T.D.; Brus, L.E., "Fluorescence intermittency in single cadmium selenide nanocrystals.",. *Nature*, **1996**. 383, 802-804.
6. Pileni, M.P., "Optical properties of nanosized particles dispersed in colloidal solutions or arranged in 2D or 3D superlattices",. *New J. Chem.*, **1998**, 693-702.
7. Henglein, A., "Radiolytic Preparation of Ultrafine Colloidal Gold Particles in Aqueous Solution: Optical Spectrum, Controlled Growth, and Some Chemical Reactions",. *Langmuir*, **1998**. 14(21), 6738-6744.
8. Link, S. ; El-Sayed, M.A., "Size and temperature dependence of the plasmon absorption of colloidal gold nanoparticles",. *J. Phys. Chem. B*, **1999**. 103(21), 4212-4217.
9. Hickman, J.J.; Ofer, D.; Laibinis, P.E.; Whitesides, G.M.; Wrighton, M.S., "Molecular self-assembly of 2-terminal, voltammetric microsensors with internal references",. *Science*, **1991**. 252, 688-691.
10. Chen, S.; Ingram, R.S.; Hostetler, M.J.; Pietron, J.J.; Murray, R.W.; Schaaff, T.G.; Khoury, J.T.; Alvarez, M.M.; Whetten, R.L., "Gold Nanoelectrodes of Varied Size: Transition to Molecule-Like Charging",. *Science*, **1998**. 280, 2098-2101.
11. Elghanian, R.; Storhoff, J.J.; Mucic, R.C.; Letsinger, R.L.; Mirkin, C.A., "Selective Colorimetric Detection of Polynucleotides Based on the Distance-Dependent Optical Properties of Gold Nanoparticles",. *Science*, **1997**. 277, 1078-1081.
12. Sass, J.K.; Sen, R.K.; Meyer, E.; Gerischer, H., "Tunnelling processes at highly doped ZnO-electrodes in aqueous electrolytes. Part II. Electron exchange with the valence band",. *Surf. Sci.*, **1974**. 44(10), 515.
13. Mulvaney, P.; Linnert, T.; Henglein, A., "Surface chemistry of colloidal silver in aqueous solution: Observations on chemisorption and reactivity",. *J. Phys. Chem.*, **1991**. 95(20), 7843-6.
14. Linnert, T.; Mulvaney, P.; Henglein, A., "Photochemistry of colloidal silver particles: The effects of N<sub>2</sub>O and adsorbed CN<sup>-</sup>",. *Ber. Bunsenges. Phys. Chem.*, **1991**. 95(7), 838-41.
15. Turkevich, J.; Stevenson, P.L.; Hillier, J., *Discuss. Faraday Soc.*, **1951**. 11, 55.
16. Henglein, A. ; Meisel, D., "Radiolytic control of the size of colloidal gold nanoparticles.",. *Langmuir*, **1998**. 14, 7392-7396.
17. Brust, M.; Walker, M.; Bethell, D.; Schiffrin, D.J.; Whyman, R., "Synthesis of thiol-derivatized gold nanoparticles in a two-phase liquid-liquid system",. *J. Chem. Soc., Chem. Commun.*, **1994**, 801-802.
18. Fink, J.; Kiely, C.; Bethell, D.; Schiffrin, D.J., "Self-organization of nanosized gold particles",. *Chem. Mater.*, **1998**. 10, 922-926.
19. George Thomas, K. ; Kamat, P.V., "Making Gold Nanoparticles Glow. Enhanced emission from a Surface Bound Probe",. *J. Am. Chem. Soc.*, **2000**. 122(11), 2655 - 2656.

20. Amihood, D.; Katz, E.; Willner, I., "Organization of Au colloids as monolayer films onto ITO glass surfaces: Application of the metal colloid films as base interfaces to construct redox-active monolayers", *Langmuir*, **1995**, *11*(5), 1313-1317.
21. Colvin, V.L.; Goldstein, A.N.; Alivisatos, A.P., "Semiconductor nanocrystals covalently bound to metal surfaces with self-assembled monolayers", *J. Am. Chem. Soc.*, **1992**, *114*, 5221-5230.
22. Fan, H. ; Lopez, G.P., "Absorption of surface-modified colloidal gold particles onto self-assembled monolayers: A model system for the study of interactions of colloidal particles and organic surfaces", *Langmuir*, **1997**, *13*, 119-21.
23. Sarathy, K.V.; Raina, G.; Yadav, R., T.; Kulkarni, G.U.; Rao, C.N.R., "Thiol-derivatized nanocrystalline arrays of gold, silver, and platinum", *J. Phys. Chem. B*, **1997**, *101*(48), 9876-9880.
24. Chen, S., "Self-assembling of monolayer-protected gold nanoparticles", *J. Phys. Chem. B*, **2000**, *104*(4), 663-667.
25. Brust, M.; Bethell, D.; Schiffrin, D. J.; Kiely, C.J., "Novel Gold-Dithiol Nano-Networks With Nonmetallic Electronic-Properties", *Adv. Mater.*, **1995**, *7*(9), 795.
26. Kiely, C.J.; Brust, M.; Bethell, D.; Schiffrin, D.J., "Spontaneous ordering of bimodal ensembles of nanoscopic gold clusters", *Nature*, **1998**, *396*(6710), 444-446.
27. Chandrasekharan, N. ; Kamat, P.V., "Assembling gold nanoparticles as thin films", *Nano Letters*, **2001**, *1*, in press.
28. Templeton, A.C.; Cliffel, D.E.; Murray, R.W., "Redox and fluorophore functionalization of water soluble. tioponin-protected gold clusters", *J. Am. Chem. Soc.*, **1999**, *121*, 7081-7089.
29. Fitzmaurice, D.; Rao, S.N.; Preece, J.A.; Stoddart, J.F.; Wenger, S.; Zaccheroni, N., "Heterosupramolecular Chemistry: Programmed Pseudorotaxane Assembly at the surface of a nanocrystal", *Angew. Chem. Int. Ed. Engl.*, **1999**, *38*(8), 1147-1150.
30. Han, W.; Li, S.; Lindsay, S.M.; Gust, D.; Moore, T.A.; Moore, A.L., "Stable binding of isothiocyanoporphyrin molecules to Au(111): An AFM study.", *Langmuir*, **1996**, *12*, 5742-5744.
31. Jana, N.R.; Pal, T.; Sau, T.K., "Nanoparticle induced fluorescence quenching", *Rad. Phys. Chem.*, **1997**, *49*(1), 127-130.
32. Makarova, O.V.; Ostafin, A.E.; Miyoshi, H.; Norris, J.R.; Meisel, D., "Adsorption encapsulation of fluorescent probes in nanoparticles", *J. Phys. Chem. B*, **1999**, *103*, 9080-9084.
33. Peng, X.; Lu, R.; Zhao, Y.Y.; Qu, L.H.; Chen, H.Y.; Li, T.J., "Control of Distance and Size of Inorganic Nanoparticles by Organic Matrices in Ordered LB Monolayer", *J. Phys. Chem.*, **1994**, *98*, 7052-7055.
34. Ribrioux, S.; Kleyman, G.; Haase, W.; Heitmman, K.; Ostermeier, C.; Michel, H., "Use of Nanogold- and Fluorescent-labeled Antibody Fv Fragments in Immunocytochemistry.", *J. Histochem. Cytochem.*, **1996**, *44*, 207-213.
35. Hainfeld, J.F.; Furuya, F.R., " A 1.4nm Gold cluster covalently attached to antibodies improves immunolabeling", *J. Histochem. Cytochem.*, **1992**, *40*, 177-184.
36. Mulvaney, P., "Spectroscopy of metal colloids. Some comparisons with semiconductor colloids.", in Book "Spectroscopy of metal colloids. Some comparisons with semiconductor colloids.", P.V. Kamat and D. Meisel, Editors. **1997**, Elsevier Science: Amsterdam. p. 99-123.
37. Kreibig, U.; Vollmer, M., Optical Properties of Metal Clusters. **1995**, Berlin: Springer.

38. Kreibig, U.; Gartz, M.; Hilger, A.; Hovel, H., "Mie-plasmon spectroscopy: A tool of surface science.", in Book "Mie-plasmon spectroscopy: A tool of surface science.", E. Pelizzatti, Editor. **1996**, Kulwer Academic Publishers: Boston. p. 499-516.
39. Linnert, T.; Mulvaney, P.; Henglein, A., "Surface chemistry of colloidal silver: Surface plasmon damping by chemisorbed  $\Gamma$ ,  $\text{SH}^-$ , and  $\text{C}_6\text{H}_5\text{S}^-$ ". *J. Phys. Chem.*, **1993**. 97(7), 679-682.
40. Gutierrez, M.; Henglein, A., "Formation of colloidal silver by "push-pull" reduction of  $\text{Ag}^+$ ". *J. Phys. Chem.*, **1993**. 97(44), 11368-70.
41. Henglein, A.; Mulvaney, P.; Linnert, T., "Chemistry of silver aggregates in aqueous solution: Non-metallic oligomers and metallic particles",. *Faraday Discuss.*, **1991**. 92, 31.
42. Persson, B.N.J., *Phys. Rev. B*, **1989**. 39, 8220.
43. Ahmadi, T.S.; Logunov, S.L.; El-Sayed, M.A., "Picosecond dynamics of colloidal gold nanoparticles",. *J. Phys. Chem.*, **1996**. 100(20), 8053-8056.
44. Mie, G., *Ann. Physik B*, **1908**. 25, 377.
45. Heilweil, E. J.; Hochstrasser, R.M., "Nonlinear spectroscopy and picosecond transient grating study of colloidal gold.",. *J. Chem. Phys.*, **1985**. 82(11), 179-183.
46. Hodak, J.; Martini, I.; Hartland, G.V., "Ultrafast study of electron-phonon coupling in colloidal gold particles",. *Chem. Phys. Lett.*, **1998**. 284(1-2), 135-141.
47. Kamat, P.V.; Flumiani, M.; Hartland, G., "Picosecond dynamics of Silver nanoclusters. Photoejection of electrons and fragmentation.",. *J. Phys. Chem. B*, **1998**. 102, 3123-3128.
48. Fujiwara, H.; Yanagida, S.; Kamat, P.V., "Visible laser induced Fusion and fragmentation of thionicotinamide capped gold nanoparticles.",. *J. Phys. Chem. B*, **1999**. 103, 2589-2591.
49. Logunov, S.L.; Ahmadi, T.S.; El-Sayed, M.A.; Khoury, J.T.; Whetten, R.L., "Electron dynamics of passivated gold nanocrystals probed by subpicosecond transient absorption spectroscopy",. *J. Phys. Chem. B*, **1997**. 101, 3713-9.
50. Shanghavi, B. ; Kamat, P.V., "Interparticle electron transfer in metal/semiconductor composites. Picosecond dynamics of CdS capped gold nanoclusters",. *J. Phys. Chem. B*, **1997**. 101(39), 7675-7679.
51. Link, S.; Burda, C.; Nikoobakht, B.; El-Sayed, M.A., "How long does it take to melt a gold nanorod? A femtosecond pump-probe absorption spectroscopic study",. *Chem. Phys. Lett.*, **1999**. 315, 12-18.
52. Link, S.; Burda, C.; Nikoobakht, B.; El-Sayed, M.A., "Laser-Induced Shape Changes of Colloidal Gold Nanorods Using Femtosecond and Nanosecond Laser Pulses",. *J. Phys. Chem. B*, **2000**. 104(26), 6152-6163.
53. Link, S.; Wang, Z.L.; El-Sayed, M.A., "How Does a Gold Nanorod Melt?",. *J. Phys. Chem. B*, **2000**. 104(33), 6767-6772.
54. Murakoshi, K. ; Nakato, Y., "Formation of Linearly Arrayed Gold Nanoparticles on Gold Single-Crystal Surfaces",. *Adv. Mater.*, **2000**. 12(11), 791-795.

## Understanding Photocleavage and Controlling Photocycloaddition

Steve Fleming  
Department of Chemistry  
Brigham Young University, Provo, UT 84602

I started my research program at Brigham Young University (BYU) in 1986. At that time there were many questions concerning the arene-olefin, meta, or 1,3-photocycloaddition reaction that were attractive to an organic chemist interested in synthetic methodology. My first graduate student, Marion Hammond, tackled the photocycloaddition of cyclopentene to the aromatic ring of cyclopropyl benzene. Undergraduate Suhail Bahu also contributed to this work. We hoped to show that the intermediate radical species would undergo ring opening of the cyclopropane. We felt that this would establish the mechanistic pathway for the arene-olefin photocycloaddition. Instead, we have found that the putative radical intermediate is too short lived. The major product is the novel cyclopropyl compound shown in Scheme 1.<sup>1</sup>

**Scheme 1.** Arene-Olefin Photocycloaddition between Cyclopropyl Benzene and Cyclopentene.

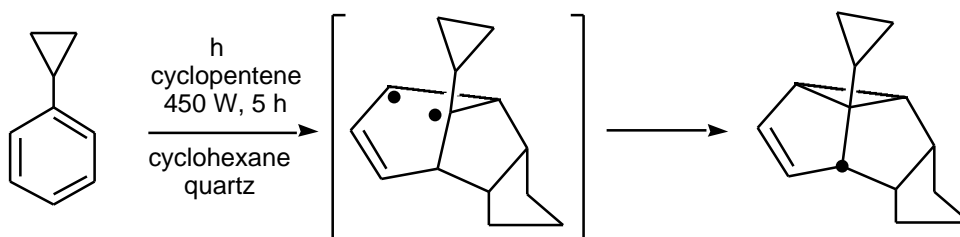

At the same time, I have worked with several undergraduates (Richard Jones,<sup>2</sup> John Holladay, Susan Ward, Vance Bachelder,<sup>3</sup> Mark Pugh, Christine Ackroyd Christensen, and Nathan Ackroyd) on the potential for intramolecular photocycloaddition between alkenes and nitrogen heterocycles such as pyridine. This project is ongoing and has promise for application in the synthesis of alkaloids and alkaloid analogues. In a related project, undergraduates Tim Turner and Brad Nilsson, studied the successful intramolecular arene-olefin photocycloaddition of a system that has silicon and oxygen in the three-atom tether (see Scheme 2).<sup>1</sup> This illustrates the utility of a temporary link between the arene and the olefin. We have demonstrated that the silicon group can be removed from the photoproduct, although the resulting diol is not very stable.

**Scheme 2.** Intramolecular Arene-Olefin Photocycloaddition.

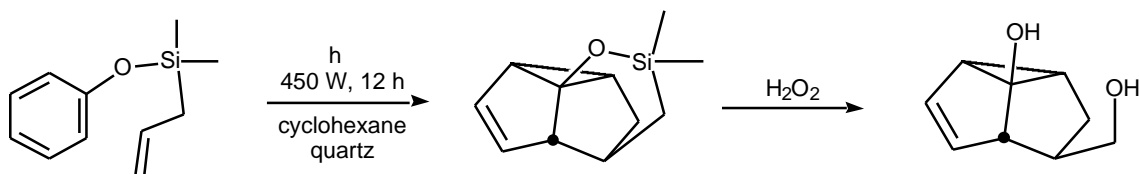

One of the projects that developed after my arrival at BYU was an investigation of p-nitrobenzylmercaptapurine riboside (NBMPR, Figure 1). BYU professor and renowned nucleoside chemist, Morris Robins, brought this compound to our attention and suggested that its photochemistry was worth investigation.

Figure 1. p-Nitrobenzylmercaptapurine Riboside.

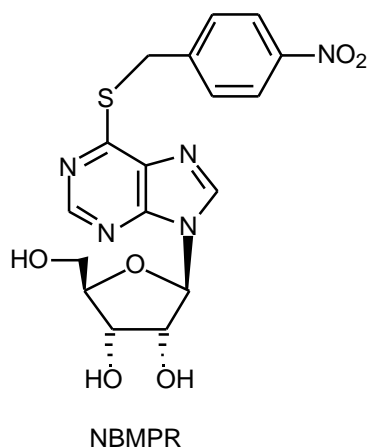

He had found previously that NBMPR was capable of photolabeling a nucleoside transport protein.<sup>4</sup> Graduate student Dave Rawlins (with help from undergraduate Jennifer Burrows Nielsen) initiated a photochemical study of the compound. We found that the benzyl sulfide group is the photoactive portion of the nucleoside. In fact, the intro group is not necessary for photochemical cleavage. We also found that the benzyl group is photolabile when attached to adenosine as shown in Scheme 3.<sup>5</sup> This is one of the few reported benzyl cleavages of neutral benzylamines.<sup>6</sup>

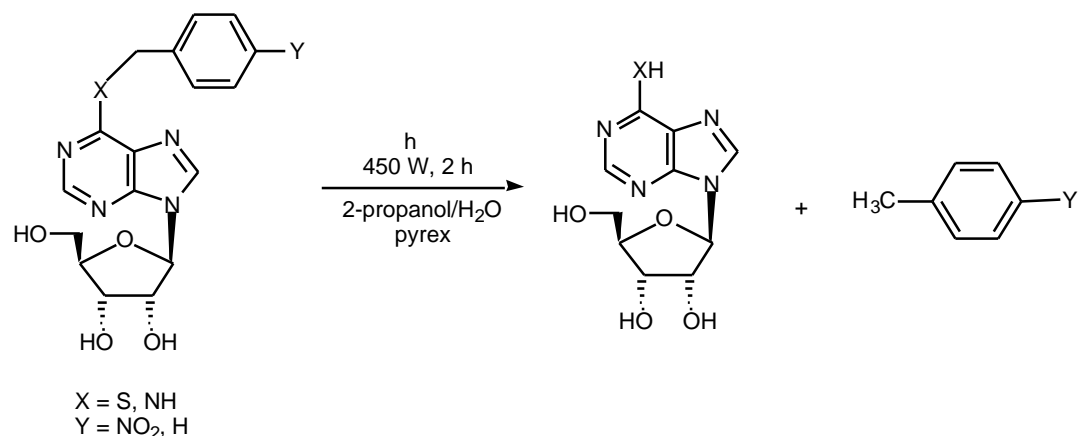
**Scheme 3.** Photochemistry of NBMPR.

We have also studied the photochemistry of benzyl ammonium salts. Graduate student Ronda Michelsen explored the nature of the benzyl cleavage for several substituted compounds.<sup>7</sup> Our results suggest that the process is a mixture of homolytic and heterolytic pathways based on the formation of biphenyl and counter-ion captured benzyl cation products. In addition, the reaction is enhanced by substitution of electron donating groups on the benzyl ring as shown in Scheme 4.

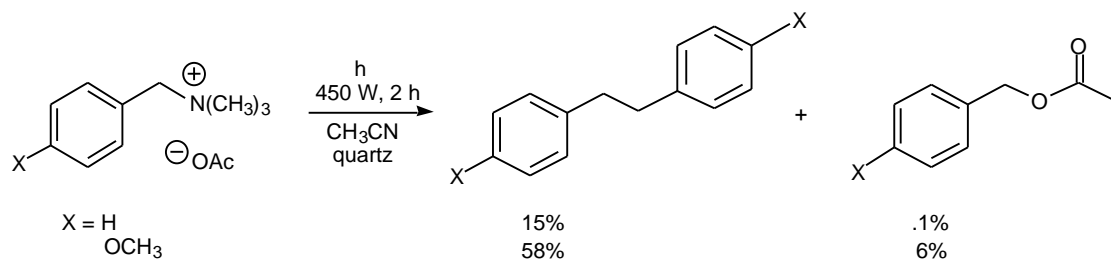
**Scheme 4.** Benzyl Cleavage Reaction of Benzylammonium Salts.

Dave Rawlins' study of the benzyl sulfide photocleavage of NBMPR led to the significant body of work that graduate student Anton Jensen carried out in my lab. Anton made several substituted benzylphenyl sulfides and measured the rate of reaction and quantum yield of disappearance for each of the compounds. We used this data to propose a radical pathway for the cleavage of the excited benzylsulfide.<sup>8</sup> Undergraduates Jason Henderson, David Beardall and Tina Johnson also worked on this project. Undergraduate Christie Morrill has worked on the potential for application of this photoactive group (the benzyl sulfide) in photoaffinity labeling. Undergraduates Mike Ridges,<sup>9</sup> Joanne Young, David Heaps, Louisa Dalton and high school teacher Karl Weenig have worked on related photoaffinity labeling projects in the group.

In 1988, Dave Rawlins had a graduate course from my colleague Bryant Rossiter.<sup>10</sup> Bryant did his graduate work with Barry Sharpless. He was one of the researchers who contributed to the current understanding

of the asymmetric Sharpless epoxidation.<sup>11</sup> One of Rossiter's requirements for the course that Dave had, was for each student to propose a novel asymmetric synthesis. Dave wrote his proposal on using a Sharpless titanium template for controlling the photocycloaddition of cinnamic acid. This was an easy project to study on the side, Dave was already working on the photochemistry of NBMPr. I told him to go for it. He found that TiCl<sub>4</sub> reacted with cinnamic acid. Irradiation of the tethered complex gave a very low yield (unoptimized) of cycloadduct. The most discouraging observation was that removal of the titanium from the photomixture was difficult and required conditions that were harsh enough to destroy the cycloadduct.

Graduate student Susan Cox Ward picked up the tethering idea and employed a silicon group, rather than titanium, as the linking atom. This was quite successful. We were able to link two cinnamyl groups and then demonstrate regio- and stereocontrol of the intramolecular photocycloaddition.<sup>12</sup> Removal of the temporary silyl tether was straightforward. This methodology was then applied to numerous other non-equivalent tethered groups, always employing at least one styrenyl chromophore as shown in Scheme 5.<sup>13</sup> Undergraduate Cara Bradford Jenkins worked Scheme 5.

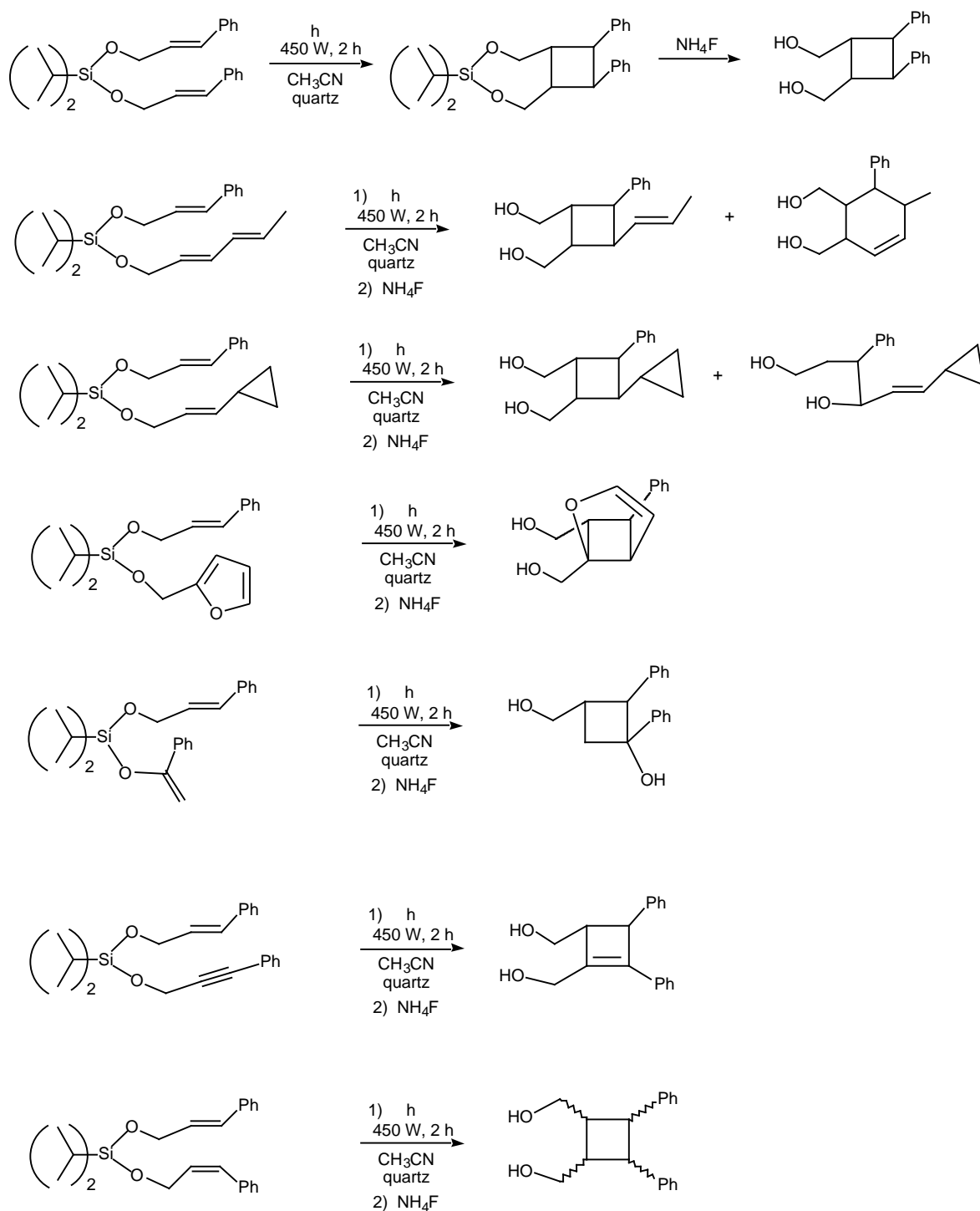
**Scheme 5.** Silyl Tethered 2+2 Photocycloadditions.

Silyl Tethered 2+2 photocycloadditions on the silyl tethered photocycloaddition between the cinnamyl group and substituted alkynes.<sup>14</sup> The generality of the cycloaddition methodology is limited, we were not able to find

cyclobutane products in the molecules that have cinnamyl groups linked to simple alkenes (see Scheme 6).

**Scheme 6.** Unsubstituted Alkene Results.

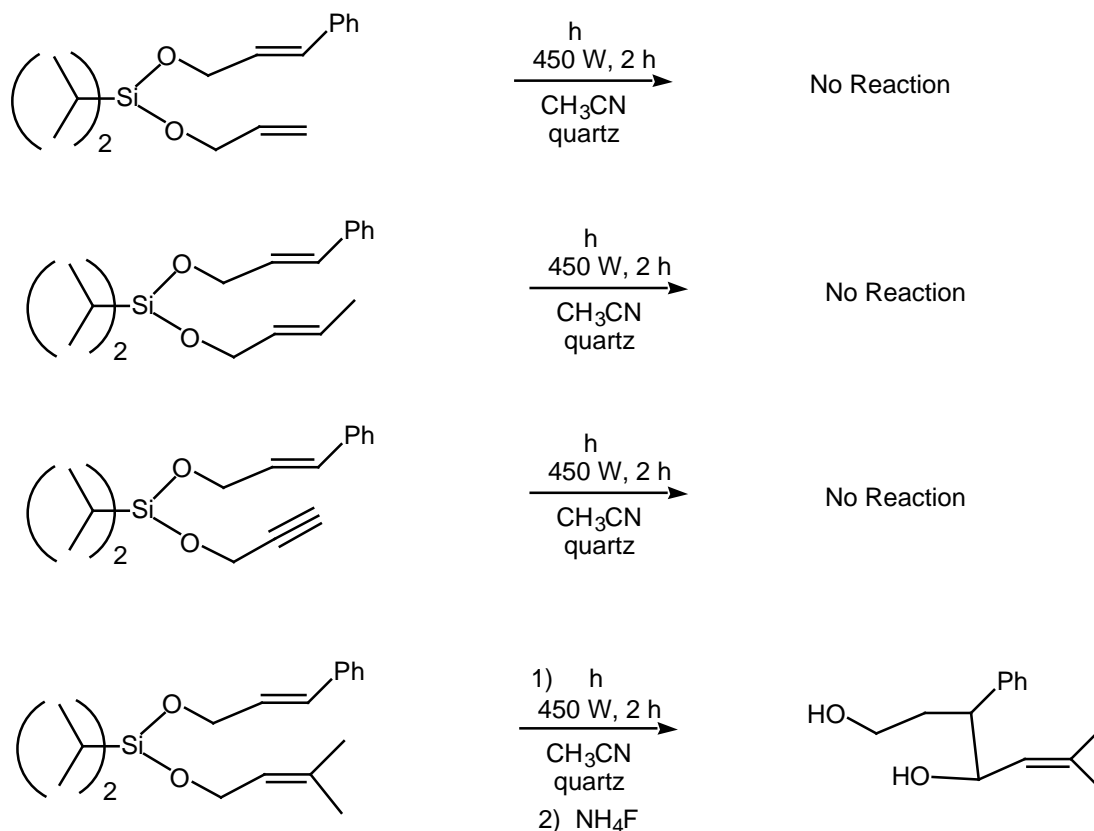

There are at least two possible mechanistic explanations that could account for the observed silyl tethered photocycloadditions. Our first thought was that cycloaddition occurs only when the alkene that is tethered to the cinnamyl group has a radical stabilizing substituent on it. This would account for the successful 2+2 between cinnamyl and the following groups: furan, diene, phenyl alkyne, carboalkoxy substituted alkyne, cyclopropyl, and phenyl substituted enol ether. There is no cycloaddition when the tethered alkene or alkyne is not substituted or only has methyl groups on it. The potential for radical stabilization was tested by the cyclopropylcycloaddition similar to Weedon's work on enone photocycloaddition.<sup>15</sup> Susan found that the vinylcyclopropyl group does not undergo ring opening in the process of photoadding to the cinnamyl group. This observation led us to conclude that either the ring closing step for the 2+2 reaction is very fast or else there is no diradical intermediate (i.e. it's a concerted reaction).

We have been intrigued by the stereoselectivity of these tethered cycloadditions.<sup>16</sup> In each case there is evidence which suggests the systems of the two alkenes are aligned. In a recent paper describing the thermal chemistry of the bis-silyl enol ether shown in Scheme 7 it was suggested that the systems of the two tethered alkenes were repelled by steric interactions.<sup>17</sup>

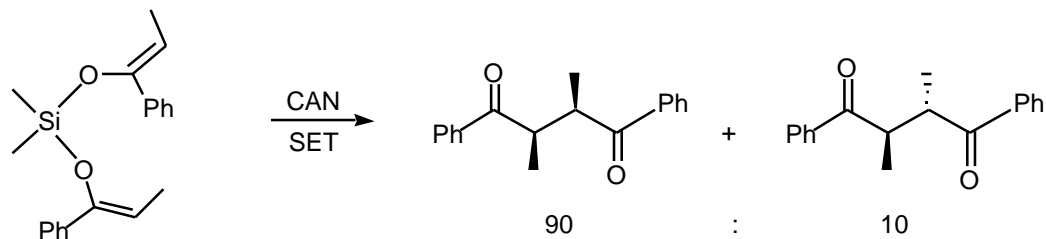
**Scheme 7.** Ground-State Chemistry of Bis-Silyl Enol Ether.

Undergraduate Ephraim Parent synthesized this compound and found that the major photoproducts actually are consistent with alignment of the  $\pi$  systems (see Scheme 8).<sup>18</sup> One explanation for the difference between the thermal chemistry where the phenyl groups prefer to be apart and the photochemistry where they prefer to align (stack), is that there is an exciplex that controls the conformation for the cycloaddition. This would also explain the lack of photocycloaddition for the methyl and unsubstituted alkenes and alkynes (vide supra) where no stacking would be possible.

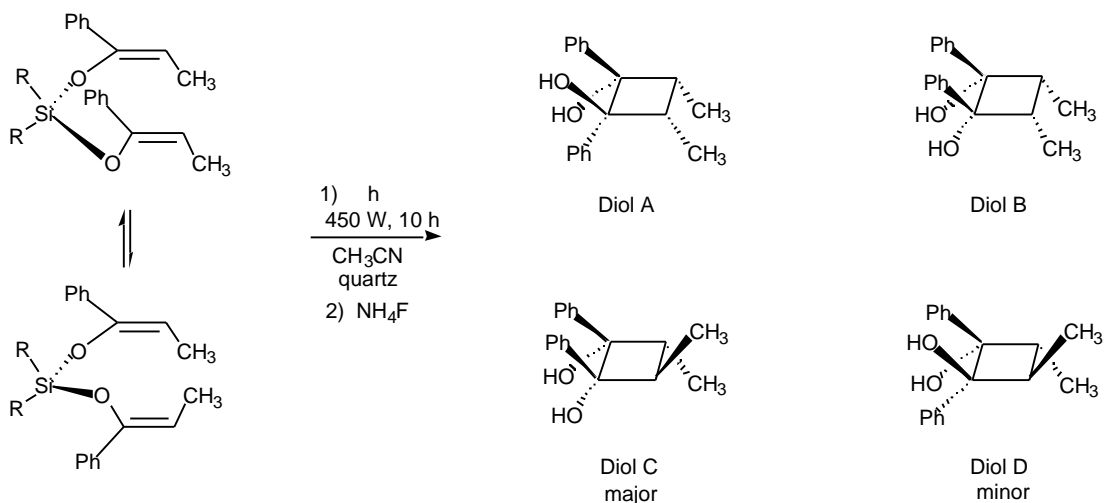
**Scheme 8.** Excited State Chemistry of Bis-Silyl Enol Ether.

Undergraduate Wally Paxton is currently working on a silyltethered molecule whose photochemical behavior should establish whether the alkenes prefer to stack or choose the more stable short-lived radical intermediate when they undergo 2+2 photocycloaddition. Along these lines, undergraduates Andrew Dadson and Judith Garcia have worked on the synthesis of silyl tethered dicinnamyl compounds that have one ring bearing an electron donating group and the second ring containing an electron withdrawing group. This should also enhance our understanding of the 2+2 reaction.

We have expended considerable time and effort working on non-covalent tethered photocycloadditions.

Graduate student Jerry Gao studied the Paterno-Büchi reaction between benzaldehyde and substituted styrenes.<sup>19</sup> The highest degree of selectivity for the cycloaddition was found with *p*-(trimethylsiloxy)methylstyrene (TMS-cinnamyl alcohol) as shown in Scheme 9. The ratios that are listed are isolated yields, recovered starting material accounts for >50% of the isolated yield. These triplet photochemical pathways are known to occur via a stepwise radical process. Our expectation was that the most stable oxetane would be obtained. Rather detailed NMR analysis allowed us to conclude that, in fact, the all-trans isomer is the only product in the photoreaction between benzaldehyde and *p*-(trimethylsiloxy)methyl styrene. However, Jerry found several cycloadducts in the irradiation of benzaldehyde and *p*-methylstyrene under the same conditions.

**Scheme 9.** Photocycloaddition of Benzaldehyde and Substituted Styrenes.

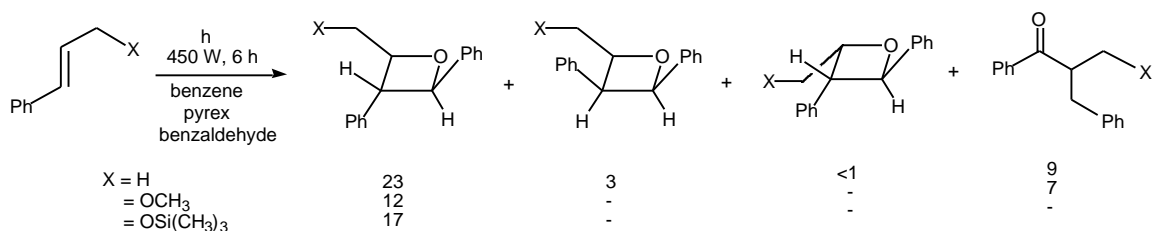

Based on this observation we suggested that the silicon group may be undergoing expanded-sphere coordination (see Figure 2). Although  $\pi$ -stacking can be ruled out in this case, low temperature studies carried out by undergraduate Heather Puett on just benzaldehyde and styrene suggest that there is potential for  $\pi$ -stacking in the Paterno-Büchi reaction.<sup>20</sup>

**Figure 2.** Expanded Sphere Silicon Coordination.

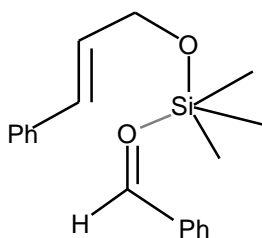

Regio- and stereocontrolled synthesis of oxetanes by using the non-covalent tethering methodology has been studied by undergraduates Bryant Jones and Brent Siemsson. Brent is currently working on a photochemical comparison between *cis* and *trans* ene-diols. We hope that his project will demonstrate the application of this methodology in the synthesis of important natural products.

Another non-covalent tethering project that has been carried out in our lab employed boron as a coordinating atom. Graduate student Cara Bradford Jenkins contributed significantly by working on the synthesis and photochemistry of various boron templates which could link alkenes for controlled photocycloaddition. Although the outcome of her project was not as fruitful as the silicon studies, she did demonstrate that one could obtain selective photochemistry as a result of boron coordination. She found that oxazaborolidine coordinated to

THF results in photoaddition to acetophenone at the  $\alpha$  position of tetrahydrofuran (see Scheme 10). This result was obtained even in the presence of cinnamyl alcohol. It was our intent to have the cinnamyl alcohol displace the THF in the boron complex. Based on the obtained photoproduct, we suspect that the THF is tethered ideally for the excited acetophenone group. All attempts to remove the last equivalent of THF from the oxazaborolidine prior to irradiation resulted in undesired thermal chemistry.<sup>21</sup>

**Scheme 10.** Boron Tethered Photochemistry.

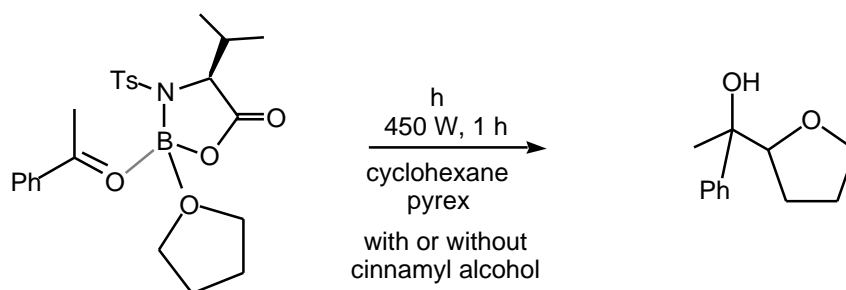

Magnesium coordination has great potential in the area of controlling photochemical reactions. Jamey Cecil is a recent graduate student whose work explored the potential for regio- and stereocontrolled photochemistry with magnesium. It was our hope that we would be able to selectively form the syn head-to-head photodimer of 2-cyclohexenone. This cyclobutane isomer has application in biochemical pathways<sup>22</sup> and no non-covalent tethered examples for its formation are found in the literature. Jamey was able to show an impressive change in the regioselectivity for the photodimerization of 2-cyclohexenone. The major photoproduct in  $\text{CH}_2\text{Cl}_2$  is the anti head-to-tail adduct.<sup>23</sup> The magnesium complex in  $\text{CH}_2\text{Cl}_2$  gave >9:1 ratio for head-to-head:head-to-tail isomers.<sup>24</sup> In order to assess the photoselectivity it was necessary to completely characterize the four photodimers of 2-cyclohexenone (see Scheme 11). Undergraduates John Hatten, Carrie Dyer,<sup>25</sup> and Tad Jessop<sup>25</sup> were involved in this effort.

**Scheme 11.** Regio- and Stereocontrolled Photocycloaddition of Magnesium Tethered Enones.

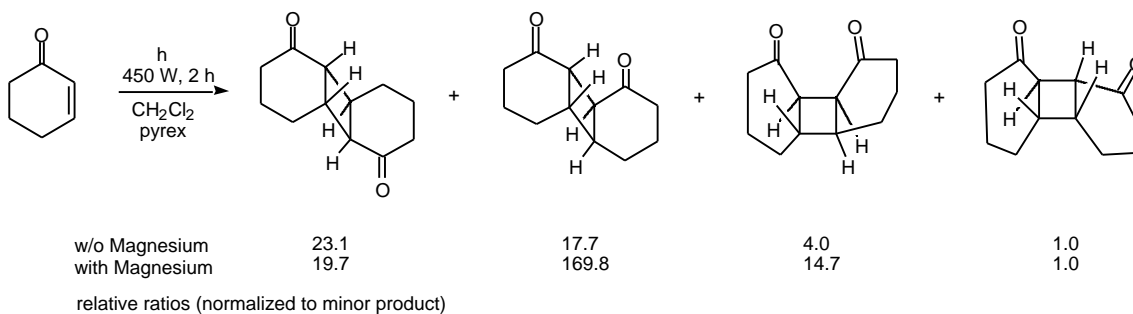

The most recent graduate student project in our lab has been carried out by Can Mao. Her study deals with the use of phosphorus for linking alkenes. We hope to produce photoadducts that can be more synthetically useful than the alkoxy silanes. The photochemistry of the silyl compounds is excellent, but removal of the silicon group can only lead to the alcohol group. The phosphate linked cyclobutane should allow for nucleophilic displacement to produce alcohols, halides, thiols, or ethers. In addition, the carbon linked alkenes will be more accessible with phosphorus compared to silicon. These carbon-phosphorus compounds will have utility by allowing further functionalization by using the Wittig reaction after the photoaddition (see Scheme 12). Thus, we expect to demonstrate a novel route to vinyl cyclobutanes which in turn can be converted into substituted

**Scheme 12.** Proposed Synthetic Utility of Carbon-Phosphorus Tethered Alkenes.

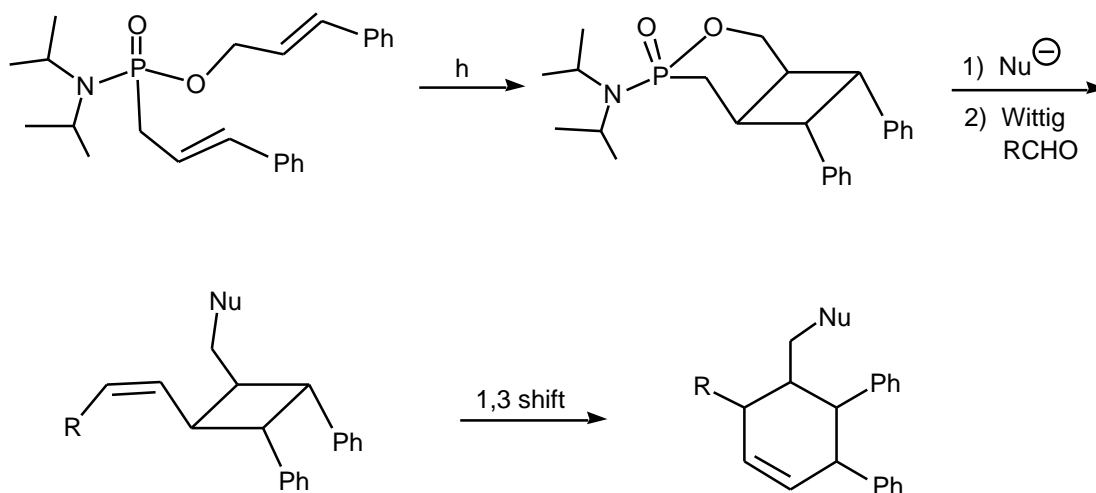

cyclohexenes in a regio- and stereoselective fashion. The synthesis of the dicinnamyl phosphate has been successful and is outlined in Scheme 13. Undergraduate Daniel Ess has helped with this aspect of our phosphate photochemistry. Mao has isolated the major photoadduct from the irradiated phosphate and is working on nucleophilic substitution of the phosphate group. She has also synthesized the carbon linked phosphine oxide necessary for the study outlined in Scheme 12.

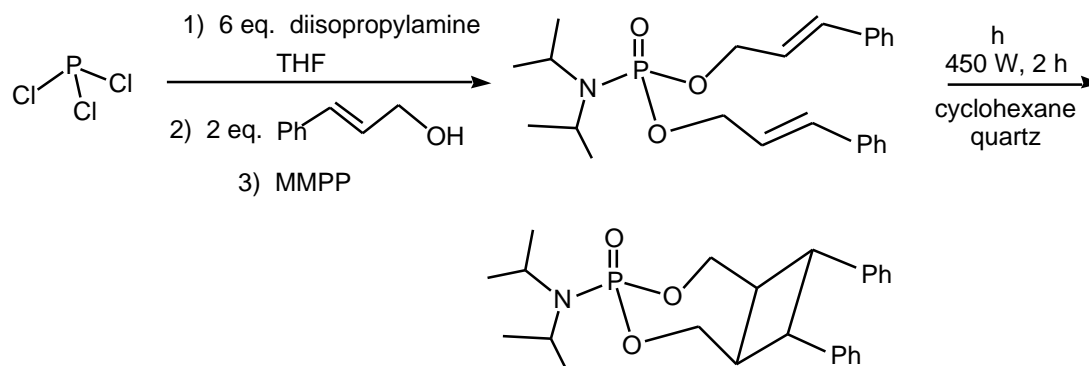
**Scheme 13.** Regio- and Stereocontrolled Photocycloaddition of Phosphate Tethered Alkenes.

This summary of our research illustrates the interest that I have in solving puzzles. We use photochemistry as a tool and we try to enhance its utility by improving the regio- and stereocontrol of carbon-carbon bond formation. This is clearly basic research. I focus my attention on teaching undergraduate and graduate students in the lab and in our weekly group meetings. I currently have 12 undergraduate and 2 graduate students in the group. The list of students whose research I have mentioned above is shown in the following table. There are 32 other undergraduates who have worked in my lab for shorter periods of time. I have made an effort to mention the work performed by students who have gone on in the field of chemistry because the readership of this research summary is chemists. All of the students (64 undergraduates and 9 graduates) have been greatly appreciated and hopefully they have benefited from their experience in my lab.

Name	In Fleming lab	After Fleming lab	Current Location
Marion Hammond	MS student	Ph.D. UC-Riverside	faculty at Las Vegas Community College
David Rawlins	MS student	Ph.D. Stanford	Bristol-Myer Squibb
Ronda Michelsen	MS student		Mom
Anton Jensen	Ph.D. student	Post Doc-Dave Schuster	faculty at Central Michigan University
Susan Cox Ward	Ph.D. student		faculty at Ricks College
Jerry Gao	MS student		Computer firm in Salt Lake City
Cara Bradford Jenkins	MS student	Ph.D. Univ. of Wisconsin	grad student at Wisconsin
Jamey Cecil	MS student		BYU Hazardous Waste manager
Mao Can	MS student		grad student at BYU
Richard Jones	BS student	MD Univ. of Nevada	private practice Las Vegas
John Holladay	BS student	Ph.D Univ. of Wisconsin	Union Carbide
Jennifer Burrows-Nielsen	BS student	Ph.D. UC San Diego	Chemistry instructor at BYU
Vance Bachelder	BS student	MD Univ. of Utah	Univ. of MN med school
Jason Henderson	BS student	Ph.D. Purdue	post-doc at CalTech
Mark Pugh	BS student	Ph.D. Univ. Utah	faculty at Ricks College
Christine Ackroyd	BS student	Ph.D. Univ. Michigan	grad student at Univ. of Michigan

David Beardall	BS student	Ph.D. Univ. Utah	grad student at Utah
Cara Bradford	BS student	MS BYU	see above
Mike Ridges	BS student	MS BYU	Boeringher-Ingelheim
Tim Turner	BS student	Ph.D. Purdue	post-doc at UC Stanford
Tina Aagard Johnson	BS Student	Ph.D. UC San Diego	grad student UC San Diego
Louisa Dalton	BS Student	MA UC Santa Cruz	science writing grad student
Dave Heaps	BS student	Ph.D. Univ. Idaho	grad student at Idaho
Brad Nilsson	BS student	MS BYU	grad student at Wisconsin
Suhail Bahu	BS student		Medichem Research
Jamie Cecil	BS student	MS BYU	see above
Joanne Young	BS student		Thiokol
Heather Puett	BS student	Univ. N. Carolina	pharmacy student
Carrie Dyer	BS student		instructor at St. Francis College, PA
Tad Jessop	BS student	Ph.D. Stanford	grad student at Stanford
Bryant Jones	BS student	Ph.D. Univ. Rochester	grad student at Rochester
John Hatten	BS student	Ph.D. Duke Univ.	grad student at Duke
Karl Weenig	HS teacher	MD Univ. Utah	med school student
Ephraim Parent	BS student	MD/Ph.D. Univ. Illinois	grad student at Illinois
Christie Morrill	BS student	Ph.D. CalTech	grad student at CalTech
Nathan Ackroyd	BS student		current student BYU
Andrew Dadson	BS student		current student BYU
Daniel Ess	BS student		current student BYU
Brent Clayton	BS student		current student BYU
Wally Paxton	BS student		current student BYU

## References

1. "Applications of 1,3-Meta Photocyclization." Fleming, S.A.; Turner, T.; Diether, A. G.; Bahu, S.; Nilsson, B. Paper submitted.
2. "Regio- and Stereoselective Oxetane Formation via Paterno-Buchi Photocycloaddition." Fleming, S. A.; Jones, R. W. *J. Het. Chem.* **1990**, 27, 1167-1168.
3. "Photochemistry of Alkenyl- and Acetal-Substituted Pyridines." Fleming, S. A.; Bachelder, V. D.; *J. Het. Chem.* **1991**, 28, 2061-2063.
4. "Photoaffinity Labeling of the Human Erythrocyte Nucleoside Transporter by N<sup>6</sup>-(p-Azidobenzyl)adenosine and Nitrobenzylthioinosine." Young, J. D.; Jarvis, S. M.; Robins, M.J.; Paterson, A. R. P. *J. Biol. Chem.* **1983**, 258,2202-2208. For a review of photoaffinity labeling see: "Chemical Reagents in Photoaffinity Labeling." Fleming, S. A. ; *Tetrahedron* **1995**, 51, 12479-12520.
5. a) "Photochemistry of the Nucleoside Membrane Transport Inhibitor 6-[(4-Nitrobenzyl)thio]-9-( -D-ribofuranosyl)purine." Fleming, S. A.; Rawlins, D. B.; Robins, M.J. *Tetrahedron Lett.* **1990**, 31, 4995-4998; b)"Photochemistry of Nucleoside Transport Inhibitor 6-S-BenzylatedThiopurine Ribonucleosides. Implications for a New Class of Photoaffinity Labels." Fleming, S. A.; Rawlins, D. B.; Samano, V.; Robins, M. J.; *J. Org. Chem.* **1992**, 57, 5968-5976.
6. For another example of benzyl-nitrogen photocleavage see: Er-Rhaimini, A.; Mohsinaly, N.; Mornet, R. *Tetrahedron Lett.* **1990**, 31, 5757-5760. For a review of benzyl cleavage reactions see: "Benzyl Cleavage Reactions." Fleming, S. A.; Pincock, J. A. *Organic Photochemistry; Molecular and Supramolecular*

- Photochemistry* **1999**, 3, 211-282.
7. "Cleavage Reactions of Benzylammonium Salts Upon Irradiation." Fleming, S. A.; Michelsen, R. G.; internal document, Dow Chemical, **1994**.
  8. a) "Photochemistry of Benzyl Phenyl Sulfide." Fleming, S. A.; Jensen, A. W.; *J. Org. Chem.* **1993**, 58,7135-7137; b) "Substituent Effects on the Photocleavage of Benzyl-Sulfur Bonds. Observation of the Meta Effect." Fleming, S.A.; Jensen, A. W.; *J. Org. Chem.* **1996**, 61, 7040-7044.
  9. "Synthesis Of Non-Steroidal Anti-inflammatory Drug Analogues For Selective Studies On The COX-II Enzyme." Fleming, S.A.; Jensen, A. W.; Ridges, M. B.; *J. Labeled Compounds & Radiopharm.* **1996**, 38, 13-18.
  10. Bryant E. Rossiter, 1953-1995.
  11. "Asymmetric Epoxidation of Homoallylic Alcohols." Rossiter, B. E.; Sharpless, K. B. *J. Org Chem.* **1984**, 49, 3707-3711.
  12. "Stereocontrolled 2+2 Photocycloaddition Via Silicon Tethered Alkenes." Fleming, S. A.; Ward, S. C.; *Tetrahedron Lett.* **1992**, 33, 1013-1016.
  13. "2 + 2 Photocycloadditions of Cinnamyloxy Silanes." Ward, S. C.; Fleming, S. A.; *J. Org. Chem.* **1994**, 59,6476-6479.
  14. "Regio-Controlled Ene-Yne Photochemical [2+2]Cycloaddition Using Silicon As A Tether." Bradford, C. L.; Fleming, S. A.; Ward, S. C.; *Tetrahedron Lett.* **1995**,36, 4189-4192.
  15. "Radical Clocks as Probes of 1,4-Biradical Intermediates in the Photochemical Cycloaddition Reactions of 2-Cyclopentenone with Alkenes" Rudolph, A.; Weedon, A. C. *Can. J. Chem.* **1990**, 68, 1590-1597.
  16. For a review of selective 2+2 photocycloaddition reactions see: "Regioselective and Stereoselective 2+2 Photocycloadditions." Fleming, S. A.; Bradford, C. L.; Gao, J. J. *Organic Photochemistry; Molecular and Supramolecular Photochemistry* **1997**, 1, 187-244.
  17. "Diastereoselective Enolate Coupling through Redox Umpolung in Silicon and Titanium Bisenolates: A Novel Concept Based on Intramolecularization of Carbon-Carbon Bond Formation." Schmittel, M.; Burghart, A.; Malisch, W. M.; Reising, J.; Sollner, R.; *J. Org. Chem.* **1998**, 63, 396-400.
  18. Ephraim Parent, Brigham Young University Honors Thesis, **2000**.
  19. "Stereoselectivity of the Paterno-Büchi Reaction." Fleming, S. A.; Gao, J. J. *Tetrahedron Lett.* **1997**, 38, 5407-5410.
  20. Heather Puett, Brigham Young University Honors Thesis, **2000**.
  21. "Boron Coordinated Photochemistry." Bradford, C. L.; Brigham Young University M.S. Thesis, **1997**.
  22. "Photodimer Recognition by Photolyase" Gilchrist, B. A.; Zhai, S.; Eller, M. S. *J. Invest. Dermatol.* **1993**,101, 666.
  23. "Mechanisms of Photochemical Reactions in Solution." Lam, E.Y.Y.; Valentine, D.; Hammond, G. S. *J. Am. Chem. Soc.* **1967**, 89, 3482-3487; b) "A Comparison of the Photodimerizations of 2-Cyclopentenone and of 2-Cyclohexenone in Acetonitrile." Wagner, P.J.; Bucheck, D. J. *J. Am. Chem. Soc.* **1969**, 91, 5090-5097; c) "Photochemical Reactions of Simple Alicyclic Enones." Eaton, P. E. *Accts. Chem.-Res* **1968**, 1, 50-57.
  24. "Magnesium Coordinated Photochemistry." Cecil, J.C.; Brigham Young University M.S. Thesis, 2000.
  25. "Structural Elucidation of a Photocycloaddition Dimer of Cyclohexenone." Cecil, J. C.; Dyer, C. W.; Fleming, S. A.; Jessop, T.C. *Analytical Science* **1999**, 15, 895-899.

## From Photochemistry to Strained Molecules.... and Back Again

**Richard P. Johnson**  
**University of New Hampshire**

When I was offered the opportunity to write for the IAPS newsletter, I thought the most interesting article would trace my group's traverses in and out of photochemistry. Although much of our recent work has concerned odd strained molecules and thermal processes, I must acknowledge that our essential inspiration was derived from photochemistry.

I was introduced to photochemistry at Syracuse University in the laboratory of Roger Hahn. In keeping with Roger's lineage to the Zimmerman group, my thesis project was to investigate the di- $\pi$ -methane chemistry of benzo-fused bicyclic compounds.<sup>1</sup> We also studied polar substituent effects in benzobornadiene rearrangements.<sup>2</sup> This was an exciting time, with the concepts of pericyclic reactions and orbital symmetry filling current literature. As a student, I remember being especially influenced by the papers of Howard Zimmerman, Nick Turro, Orville Chapman, Harry Morrison, and Pete Wagner, as well as Josef Michl's lucid series of papers on potential energy surfaces in the now defunct *Molecular Photochemistry*.<sup>3</sup> In 1976, I took up a postdoctoral with Charles Jefford at the University of Geneva, Switzerland. My postdoctoral work was mostly non-photochemical, but left me with growing interests in carbene chemistry and the synthesis of odd molecules. My greatest challenge in Geneva was presenting a lecture course on photochemistry in mediocre French. Vive la photochimie!

In early 1978, I returned to the US to begin an NIH postdoctoral fellowship with Howard Zimmerman in Madison. Arriving in Madison during January is recommended neither for body nor soul; I soon got frostbite cross-country skiing on Lake Mendota in sub-zero weather! Zimmerman's group in this era consisted of about a dozen very talented graduate students, including Steve Fleming, Richard Bunce and John Penn, but I was surprised to find myself the sole postdoctoral. Vinylcyclopropene chemistry was a timely topic<sup>4</sup> and Howard asked me to investigate the chemistry of vinylcyclobutenes to see if parallel reactions might occur. In brief, they did *not* and nine months of synthetic effort and "exploratory photochemistry" did not lead to what Howard considered publishable results, even though I prepared numerous interesting molecules. Howard next asked me to "finish up" a project left behind by Diego and Mercedes Armesto; this proved to be a winner and I discovered the first clear "retro" di- $\pi$ -methane rearrangement.<sup>5</sup>

### Getting Suddenly Polarized

In August, 1979, I began a faculty position at Iowa State University. With triple digit start-up packages now the norm in academics, I recall without nostalgia that my start-up funding totaled about \$11,000 and it was a struggle to get started. As an assistant professor, I also endured an assortment of hazing from my colleagues. I can't imagine this sort of nonsense occurring today! One of the more interesting topics in photochemistry was Lionel Salem's "sudden polarization" effect, which was suggested to play an important role in vision.<sup>6</sup> Salem's theory held that relaxation in singlet excited states of  $\pi$  bonds should lead to minima with zwitterionic character, perhaps *suddenly* as the structure approached a 90 degree twist. The combination of theory and experiment was

attractive, thus my students and I set out to find experimental evidence through photochemical reactions. We first considered methylenecyclopropene excited states; while the results were of theoretical interest, these substances are too scarce for experiments.<sup>7</sup> Fulvenes were easier to work with and seemed a safe bet for polarized excited states but these were uniformly the most *unreactive* substances I have seen. My students eventually grew tired of preparing and irradiating different fulvenes, only to see nothing happen. Fortunately, it was not long before we discovered cumulenes and a rich assortment of interesting chemistry unfolded.

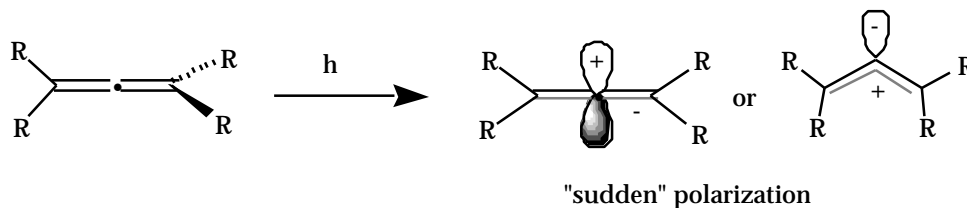

### The Photochemistry of Allenes

Our first prediction was that singlet excited states of allene would be polarized as shown below. In support of this simple idea, my student Michael Klett quickly discovered that tetraphenylallene smoothly adds methanol, even under basic conditions.<sup>8a</sup> MCSCF calculations supported the existence of strongly polarized minima.<sup>9</sup> We also showed that generation of allene radical cations by SET gives the opposite regiochemistry.<sup>8a,10</sup>

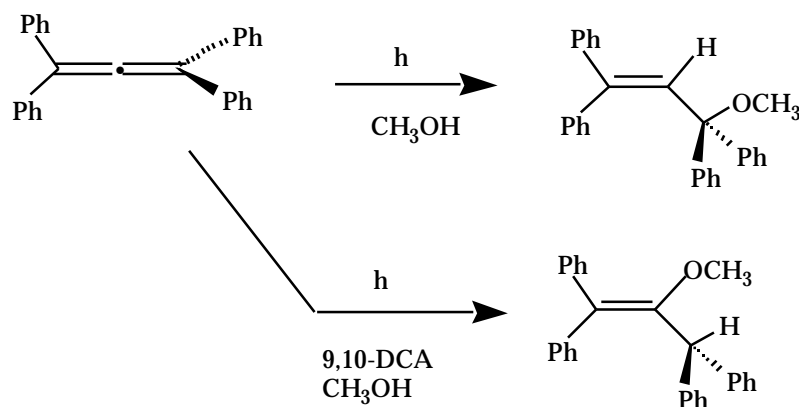

Little was known about allene photorearrangements.<sup>11</sup> In the spirit of "exploratory organic photochemistry", we set about to see what might happen. Coincidentally, Mark Steinmetz at Marquette was working on the same problem.<sup>12</sup> In addition to bond isomerization, we found that allene singlet excited states give predominantly 1,2-shifts to afford cyclopropenes or vinylcarbenes, with 1,3-shifts a minor process.<sup>13</sup> The most efficient cases involved hydrogen migration, as we observed with 1,2-cyclononadiene<sup>14</sup> or triphenylallene.<sup>15</sup> Independent generation of putative carbene intermediates by cyclopropene photolysis or through diazo compounds usually gave similar– but not identical – products. Phenylallene triplets were generally unreactive but the simple

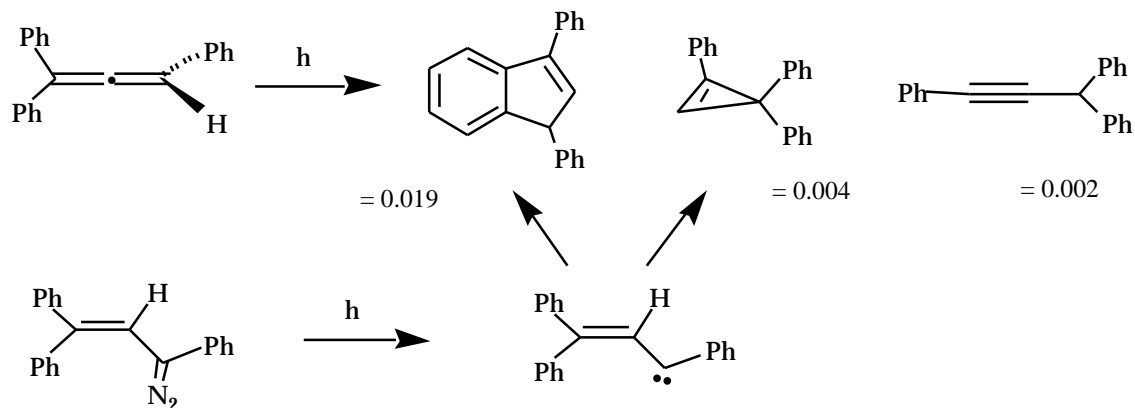

cyclic allenes give some amazing structures which arise from hydrogen abstraction.<sup>14,16</sup> For example, benzene sensitization of 1,2-cyclodecadiene afforded five tricyclic isomers, which presumably derive from cis and trans triplet cyclopropylidenes.<sup>16</sup> *t*-Butyl-1,2-cyclooctadiene yielded quite different products from vapor or solution phase photolyses.<sup>17</sup> These reactions remain poorly understood and should be revisited.

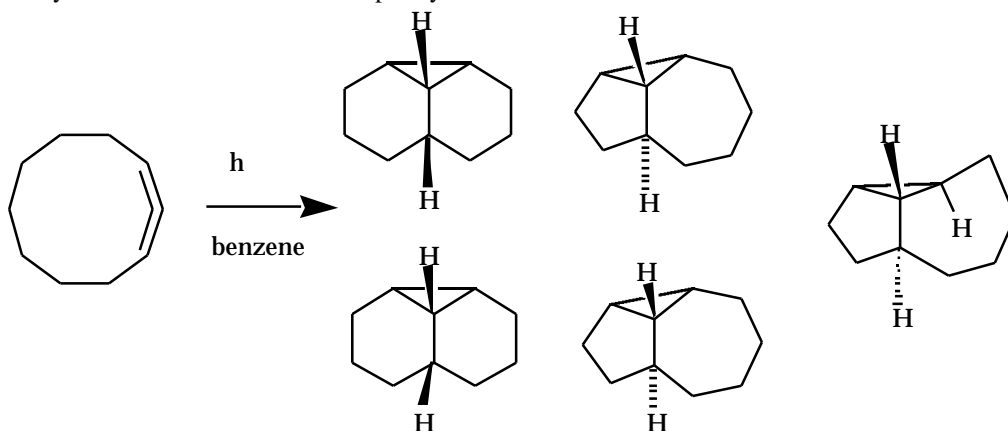

### On to Odd Molecules

I owe my interest in strained cyclic cumulenes to a 1982 seminar visit to ISU by William M. Jones. Bill had found experimental evidence that 1,2-cyclohexadiene is chiral<sup>18</sup>, which stood in contrast to the prevailing view that it should have a planar zwitterionic structure.<sup>19</sup> We immediately recognized the zwitterion as an excited state (!)

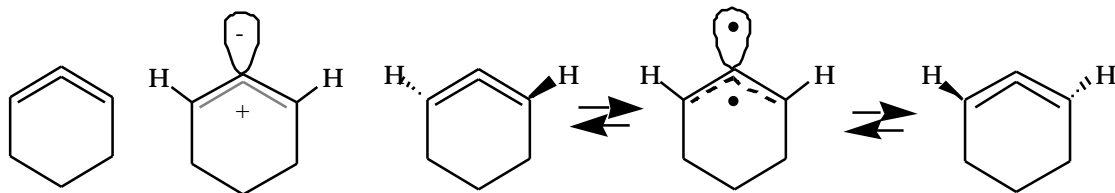

and, in collaboration with Mike Schmidt, soon published an MCSCF study that supported the chiral structure for 1,2-cyclohexadiene, further predicting a 15 kcal/mol barrier to racemization.<sup>20</sup> This paper was followed by the synthesis of 1,2,3-cyclononatriene, the smallest isolable cyclic butatriene<sup>21</sup>, and *t*-butyl-1,2-cyclooctadiene<sup>22</sup>, then the smallest stable cyclic allene. Soon after this, I moved to the University of New Hampshire where we

embarked on a systematic quest to establish the limits for structure and isolability in the homologous series of cyclic cumulenes. Ab Initio computations of increasing sophistication have been used to guide our efforts.

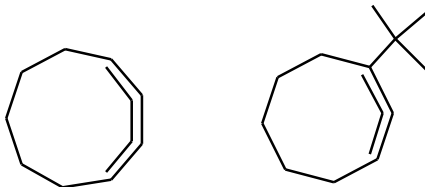

Many interesting molecules have followed. In 1993, we reported the first syntheses of 1,2,3-cyclohexatriene and cyclohexene-3-yne, two new isomers of benzene.<sup>23</sup> My collaborator on this project was graduate student William Shakespeare. Later efforts produced 1,2,3-cyclooctatriene.<sup>24</sup> Laren Tolbert's group presented a very creative synthesis of 1-phenyl-1,2-cyclohexadiene through anion photochemistry, while we prepared it by more conventional methods.<sup>20c</sup> Parenthetically, we have tried to make 1,2,3-cyclohexatrienes through dienyne photocyclization, but this did not work.

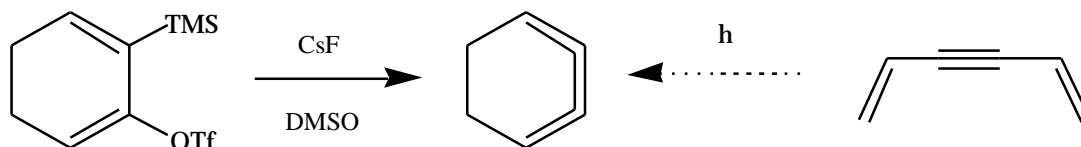

### Photochemistry of Enynes

Some structures, most notably 1,2-cyclopentadiene and 1,2,3-cyclopentatriene, have proven elusive. Nevertheless, we pressed on towards 1,2-cyclobutadiene, a bizarre substance almost unknown in *Chemical Abstracts*. Drawing from both the abundant literature on diene photochemistry and the well-known Bergman rearrangement<sup>25</sup>, we wondered if conjugated *enynes* might reversibly photocyclize to 1,2-cyclobutadienes and thereby shuttle carbons from one end to the other. Surely, we are not the first to draw this bizarre reaction, but we must have been the first who chose not to crumple the page and discard it! One suggestive example existed in a report by Herbert Maier's group on photoreaction of cycloocten-3-yne.<sup>26</sup> I posed this problem to Manli Zheng and - to our astonishment - the photoreaction worked splendidly. Irradiation of enynes leads to slow establishment of a photoequilibrium.<sup>27</sup> Incorporating an alkyl group at C1 shows that bond isomerization is a much more rapid process. Extended conjugation with phenyl substitution destroys the reaction. We now have quite a number of examples of this amazing singlet reaction. Our calculations support the existence of singlet 1,2-cyclobutadiene in a shallow minimum ca. 74 kcal/mol above vinylacetylene, still well below the energy of the enyne excited state. We have been unable to trap an intermediate but 1,2-cyclobutadiene still seems to provide the best mechanism.

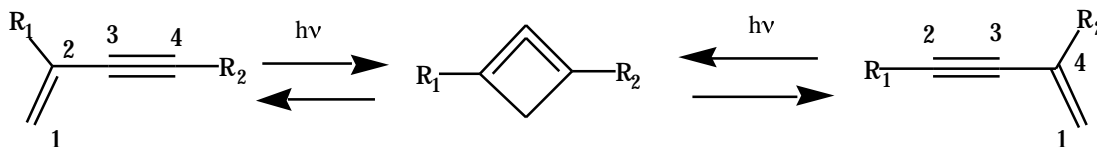

### Dehydropericyclic Reactions

Where to go next? Enyne photochemistry provided the key to a general principal which I have often referred to as "dehydropericyclic" reactions and which offers routes to many reactive molecules. Simply stated, if

one systematically removes two (or more) hydrogens from an ordinary pericyclic reaction, the cyclized product invariably will be a strained molecule.<sup>28</sup> Thus, dienes become enynes or even diyenes (see below) as components in reactions. Fitting the Bergman reaction into the six electron scheme shows that enyne photoreactions are just the four electron homolog. Many scattered examples of dehydropericyclic reactions already exist in the literature<sup>29</sup>; surely more can be invented with this approach. We applied the dehydropericyclic principle systematically to the Diels-Alder reaction and have now reported intramolecular versions of *all* of the cycloadditions shown below.<sup>30</sup> Earlier work existed on enyne cycloadditions<sup>31</sup> but we were the first to demonstrate that diynes can function as the diene component. Benzynes can be made through a [2+4] cycloaddition. Amazingly, ab initio calculations predict that the activation energy increases only about 10 kcal/mol when a *diene* is replaced with a *diyne*. Photochemical versions of these fascinating processes exist; for example Paul Margaretha's group recently published an enone + enyne photocycloaddition, with secondary trapping of the intermediate 1,2-cyclohexadiene.<sup>32</sup>

#### Pericyclic Reactions

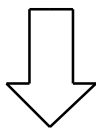
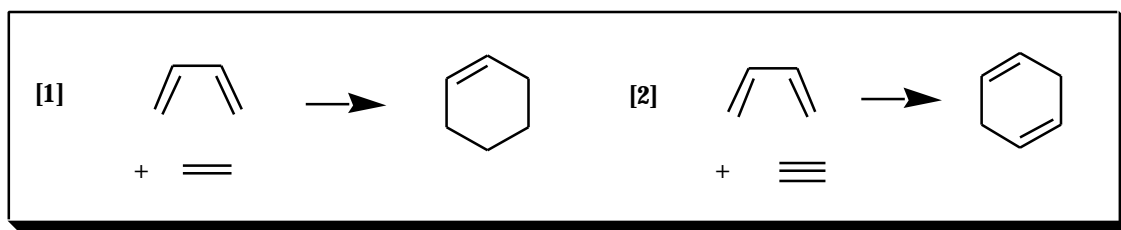

#### Dehydropericyclic Reactions

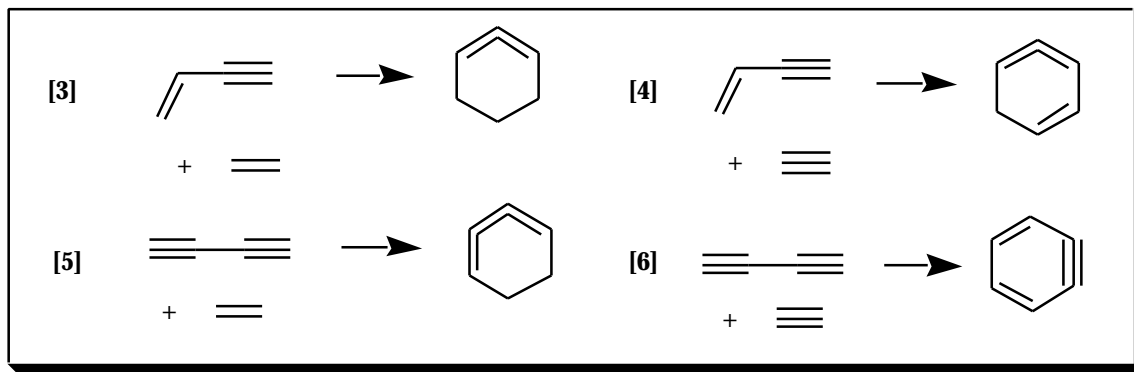

#### *trans*-Double Bonds in Odd Places

Photochemistry provides the best route to transient *trans*-cyclohexenes, which are predicted to be ca. 53 kcal/mol above their *cis* stereoisomers. We have used theory to study the structure of *trans* cyclohexenes and we predict a rotational barrier of ca. 10 kcal/mol<sup>33</sup>, in good agreement with Dick Caldwell's flash photolysis experiments on phenylcyclohexene isomers.<sup>34g</sup> More recently, we have explored the *s-trans* side of the Diels-Alder cycloaddition, a region that has remained *terra incognita* in spite of the abundant literature on this reaction. Our calculations predict both concerted and stepwise routes from *s-trans* diene to *trans*-cyclohexene.<sup>35</sup> Of course,

in contrast to the *s-cis* side, this reaction is *endothermic* because of product strain. Nevertheless, we are working to design cycloadditions where the *s-trans* side might be favored.

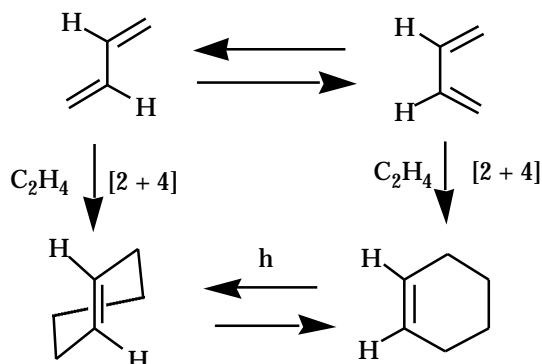

Stranger molecules beckon. Can a *trans* bond exist in benzene and are such structures involved as transient photoproducts in benzene photochemistry? This suggestion has appeared in the literature<sup>36</sup>, but no evidence existed to support it. We found a shallow minimum corresponding to *cis,cis,trans*-1,3,5-cyclohexatriene lying ca. 100 kcal/mol above benzene.<sup>37</sup> Perhaps more importantly, this exotic benzene isomer lies on the path for conrotatory ring opening of Dewar benzene. In contrast to long held views dating back to the original syntheses of Dewar

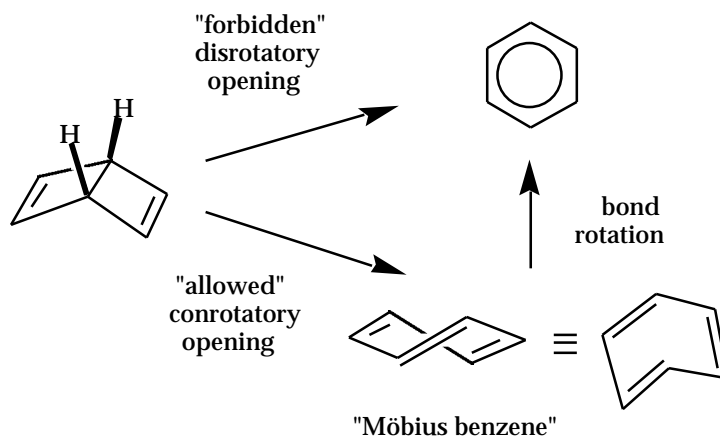

benzene<sup>38</sup>, we predict conrotatory ring opening to be of lower energy than disrotatory. This is an astounding triumph for orbital symmetry. At this point, it is unclear whether this remarkable structure plays any role in benzene photoreactions.

### Phenanthrene as a Carbene Storage Device

It has long been known that cyclopropanes photofragment to alkenes + carbenes. This reaction has been referred to as the Griffin fragmentation, in order to recognize Gary Griffin's contributions to this field.<sup>39</sup> We found that photolysis of the adduct of dichlorocarbene to phenanthrene smoothly regenerates the carbene, which was easily trapped by alkenes. This led to a collaborative effort with John Chateaufeuf, who measured the first absolute rate constants for dichlorocarbene addition.<sup>40</sup> It was soon obvious that this structure is easily converted into precursors

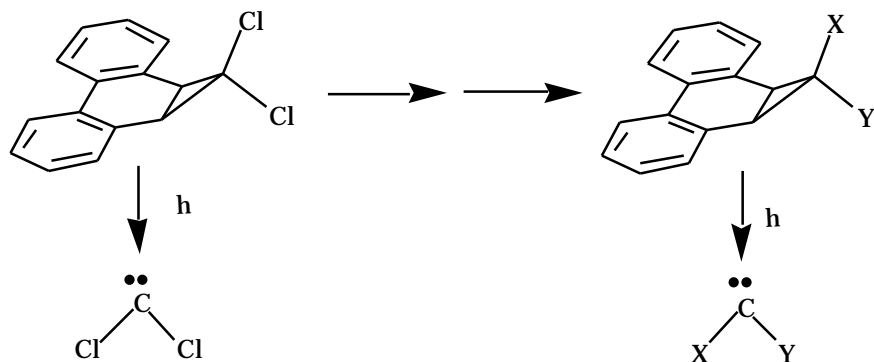

for numerous other fundamental carbenes. Collaboration with Matt Platz's group led to studies on chlorocarbene, benzylchlorocarbene and others.<sup>41</sup> Maitland Jones has applied the same approach.<sup>42</sup>

### Conclusions

Stranger things are in progress! As we explored the dehydropericyclic theme, we wondered if 1,3-dienes might photochemically or thermally cyclize to the extraordinary structure known as trialene. This reaction appears to have been first suggested by Michael Dewar.<sup>43</sup> Bond-switch isomerization and cycloreversion would exchange carbon atoms. Again, we have used both experiments and theory to study this fascinating problem and our results will shortly be submitted for publication.<sup>44</sup>

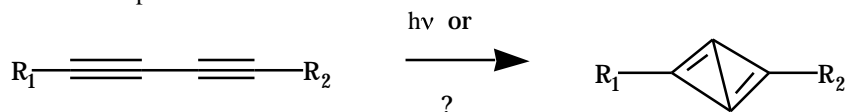

Photochemical and thermal processes provide routes to numerous high energy molecules that challenge the limits of organic structure. Our experience - which builds on the work of many other scientists - has shown that carefully designed reactions can provide evidence for some truly extraordinary molecules.

### Acknowledgements

I have been privileged to work with many excellent graduate and undergraduate students, postdoctorals and professional collaborators whose work is described above. Continued support from the National Science Foundation and a grant from the NIH have made this work possible.

### References

- (1) (a) Hahn, R. C.; Johnson, R. P. *J. Amer. Chem. Soc.* **1975**, *97*, 212. (b) Hahn, R. C.; Johnson, R. P. *J. Amer. Chem. Soc.* **1976**, *98*, 2600.
- (2) Hahn, R. C.; Johnson, R. P. *J. Amer. Chem. Soc.* **1977**, *99*, 1508.
- (3) Michl, J. *Molecular Photochem.* **1972**, *4*, 243, 257, 287.
- (4) (a) Zimmerman, H. E.; Aasen, S. *J. Amer. Chem. Soc.* **1977**, *99*, 2342. (b) Padwa, A.; Blacklock, T. J.; Getman, D.; Hatanake, N.; Loza, R. *J. Org. Chem.* **1978**, *43*, 1481.
- (5) Zimmerman, H. E.; Armesto, D.; Amezua, M. G.; Gannett, T. P.; Johnson, R. P. *J. Am. Chem. Soc.* **1979**, *101*, 6367.
- (6) For representative early papers on "sudden polarization", see: (a) Salem, L. *Acc. Chem. Res.* **1979**, *12*,

87. (b) Bonacic-Koutecky, V.; Buenker, R. J.; Peyerimhoff, S. D. *J. Am. Chem. Soc.* **1979**, *101*, 5917.  
(c) Bonacic-Koutecky, V. *J. Am. Chem. Soc.* **1978**, *100*, 396. (d) Meerman-Van Benthem, C. M.; Jacobs, H. J. C.; Mulder, J. J. C. *Nouv. J. Chim.* **1978**, *2*, 123. (e) Karafiloglou, P.; Evleth, E. M., *Theochem* **1983**, *11*, 351. (f) Bonacic-Koutecky, V.; Koutecky, J.; Michl, J. *Angew. Chem. Int. Ed. Engl.* **1987**, *26*, 170.
- (7) Johnson, R. P.; Schmidt, M. W. *J. Am. Chem. Soc.*, **1981**, *103*, 3244.
- (8) (a) Klett, M.W.; Johnson, R. P. *Tetrahedron Letters*, **1983**, 1107. (b) Kirmse has recently used LFP and labeling studies to show that both direct photoaddition and carbene mechanisms may be involved in additions to allenes: Kirmse, W.; Strehlke, I. K.; Steenken, S. *J. Am. Chem. Soc.* **1995**, *117*, 7007.
- (9) Lam, B.; Johnson, R. P. *J. Am. Chem. Soc.* **1983**, *105*, 7479.
- (10) (a) Klett, M. W.; Johnson, R. P. *J. Am. Chem. Soc.* **1985**, *107*, 6615. (b) For other examples of photogenerated allene radical ions, see: Somekawa, K.; Haddaway, K.; Mariano, P. S.; Tossell, J. A. *J. Am. Chem. Soc.* **1984**, *106*, 3060.
- (11) For some early papers on allene photochemistry, see: (a) Ward, H. R.; Karafiath, E. *J. Amer. Chem. Soc.* **1969**, *91*, 7475. (b) Chapman, O. *Pure Appl. Chem.* **1975**, 511. (c) Rodriguez, O.; Morrison, H. *J. Chem. Soc. Chem. Commun.* **1971**, 679. (d) Drucker, C. S.; Toscano, V. G.; Weiss, R. G. *J. Am. Chem. Soc.* **1973**, *95*, 6482. (e) Karan, H. I. *J. Org. Chem.* **1981**, *46*, 2186.
- (12) Steinmetz, M. G.; Mayes, R. T.; Yang, J.-C. *J. Am. Chem. Soc.* **1982**, *104*, 3518.
- (13) Johnson, R. P. "Cumulene Photochemistry", *Organic Photochemistry*, Volume 7, Chpt. 2, A. Padwa, Editor, 1985.
- (14) (a) Stierman, T. J.; Johnson, R. P. *J. Am. Chem. Soc.*, **1983**, *105*, 2492. (b) Stierman, T. J.; Johnson, R. P. *J. Am. Chem. Soc.*, **1985**, *107*, 3971 (c) Stierman, T. J.; Shakespeare, W. M.; Johnson, R. P. *J. Org. Chem.*, **1990**, *55*, 1043.
- (15) (a) Klett, M. W.; Johnson, R. P., *Tetrahedron Letters*, **1983**, 2523. (b) Klett, M. W.; Johnson, R. P. *J. Am. Chem. Soc.*, **1985**, *107*, 3963.
- (16) Price, J. D.; Johnson, R. P. *J. Am. Chem. Soc.* **1985**, *107*, 2187.
- (17) Price, J. D.; Johnson, R. P. *J. Org. Chem.* **1991**, *56*, 6372.
- (18) Balci, M.; Jones, W. M.; *J. Am. Chem. Soc.*, **1980**, *102*, 7607.
- (19) Dillon, P. W.; Underwoor, G. R. *J. Am. Chem. Soc.*, **1974**, *96*, 779.
- (20) (a) Schmidt, M. W.; Angus, Jr., R. O.; Johnson, R. P. *J. Am. Chem. Soc.*, **1982**, *104*, 6838. (b) Angus, Jr., R. O.; Schmidt, M. W.; Johnson, R. P. *J. Am. Chem. Soc.* **1985**, *107*, 532. (c) For later work on 1,2-cyclohexadienes, see: Tolbert, L. M.; Islam, Md. N.; Johnson, R. P.; Loiselle, P. M.; Shakespeare, W. C. *J. Am. Chem. Soc.* **1990**, *112*, 6416.
- (21) (a) R. O. Angus, Jr. and R. P. Johnson\*, "Small-Ring Cyclic Cumulenes: The Structure and Energetics of Cyclic Butatrienes and the Synthesis of 1,2,3-Cyclononatriene", *J. Org. Chem.* **49**, 2880-2883 (1984) (b) Price, J. D.; Johnson R. P. *Tetrahedron Letters* **1986**, *27*, 4679.
- (22) Johnson, R. P. "Strained Cyclic Cumulenes", *Chem. Rev.* **1989**, *89*, 1111.
- (23) Shakespeare, W. C.; Johnson, R. P. *J. Am. Chem. Soc.* **1990**, *112*, 8578.
- (24) Hernandez, S.; Kirchhoff, M. M.; Swartz Jr., S. G.; Johnson, R. P. *Tetrahedron Letters* **1996**, *37*, 4907.
- (25) Bergman, R. G. *Acc. Chem. Res.* **1973**, *6*, 25.
- (26) Meier, H.; Konig, P. *Nouv. J. Chim.* **1986**, *10*, 437. Zheng, M.; DiRico, K. J.; Kirchhoff, M. M.; Phillips, K.; Cuff, L. M.; Johnson, R. P. *J. Am. Chem. Soc.* **1993**, *115*, 12167.
-

- (28) Bradley, A. Z.; Kaoust, K. J.; Johnson, R. P., manuscript in preparation.
- (29) For example (a) Mitchell, G. H., Sondheimer, F. *J. Am. Chem. Soc.* **1969**, *91*, 7520. Dolbier, Jr., W. R.; Garza, O. T.; Al-Sader, B. H. *J. Am. Chem. Soc.* **1975**, *97*, 5038. (c) Morwick, T.; Doyon J; Paquette, L. A. *Tetrahedron Lett.* 1995, *36*, 36, 2369. (d) Eberbach, W.; Fritz, H.; Laber, N. *Angew. Chem. Internat. Ed. Engl.* **1988**, *27*, 568.
- (30) (a) Burrell, R. C.; Daoust, K. J.; Bradley, A. Z.; DiRico, K. J.; Johnson, R. P. *J. Am. Chem. Soc.* **1996**, *118*, 4218. (b) Bradley, A. Z.; Johnson, R. P. *J. Am. Chem. Soc.* **1997**, *119*, 9917.
- (31) For example: (a) Norton, J. A. *Chem. Rev.* **1942**, *31*, 319. (b) Kloetzel, M. C. *Org. React.* **1948**, *4*, 1. (c) Butz, L. W.; Gaddis, A. M.; Butz, E. W. J.; Davis, R. E., *J. Org. Chem.* **1940**, *5*, 379. (d) Danheiser, R. L.; Gould, A. E.; Fernandez de la Predilla, R.; Helgason, A. L. *J. Org. Chem.* **1994**, *59*, 5514.
- (32) Witte, B.; Margaretha, P. *Org. Letters* **1999**, *1*, 173.
- (33) Johnson, R. P.; DiRico, K. J. *J. Org. Chem.*, **1995**, *60*, 1074.
- (34) For papers on *trans* cyclohexenes, see: (a) Kropp, P. J.; Fravel Jr., H. G.; Fields, T. R. *J. Am. Chem. Soc.* **1976**, 981, 840. (b) Inoue, Y.; Takamuku, S.; Sakurai, H. *J. Chem. Soc. Perkin II* **1977**, 1635. (c) Dauben, W. G.; vanRiel, H. C. H. A.; Robbins, J. D.; Wagner, G. J. *J. Am. Chem. Soc.* **1979**, *101*, 6383. (d) Inoue, Y.; Matsumoto, N.; Hakushi, T.; Srinivasan, R. *J. Org. Chem.* **1981**, *46*, 2267. (e) Saltiel, J.; Marchand, G.R.; Bonneau, R. *J. Photochem.*, **1985**, *28*, 367. (f) Goodman, J.L.; Peters, K.S.; Misawa, H.; Caldwell, R.A. *J. Am. Chem. Soc.* **1986**, *108*, 6803. (g) Strickland, A. D.; Caldwell, R. A. *J. Physical Chem.* **1993**, *97*, 13394.
- (35) Bradley, A. Z.; Kociolek, M. G.; Johnson, R. P. *J. Org. Chem.* **2000**, *65*, 7134 - 7138.
- (36) (a) Farenhorst, E. *Tetrahedron Lett.* **1966**, 6465. For comments on this work, see also: (b) Mulder, J. J. C. *J. Am. Chem. Soc.* **1977**, *99*, 5177. (c) Bryce-Smith, D.; Gilbert, A. "Rearrangements in Ground and Excited States", Demayo, P. ed., Academic Press, New York, 1980. Volume 3.
- (37) Johnson, R. P.; Daoust, K. J. *J. Am. Chem. Soc.* **1996**, *118*, 7381.
- (38) (a) van Tamelen, E. E.; Pappas, S. P. *J. Am. Chem. Soc.* **1963**, *85*, 3297. (b) van Tamelen, E. E. *Acc. Chem. Res.* **1972**, *5*, 186. (c) Wilzbach, K. E.; Ritscher, J. S.; Kaplan, L. *J. Am. Chem. Soc.* **1967**, *89*, 1031.
- (39) Griffin, G. W. *Angew. Chem. Internat. Ed. Engl.* **1977**, *10*, 537.
- (40) Chateaneuf, J. E.; Johnson, R. P.; Kirchoff, M. M. *J. Am. Chem. Soc.* **1990**, *112*, 3217.
- (41) (a) Robert, M.; Toscano, J. P.; Platz, M. S.; Abbot, S. C.; Kirchoff, M. M.; Johnson, R. P. *J. Physical Chem.* **1996**, *100*, 18426. (b) Robert, M.; Likhotvorik, I.; Platz, M. S.; Abbot, S. C.; Kirchoff, M. M.; Johnson, R. P. *J. Physical Chem.* **1998**, *102*, 1507. (c) Nigam, M.; Platz, M. S.; Showalter, B. M.; Toscano, J. P.; Johnson, R. P.; Abbot, S. C.; Kirchoff, M. M. *J. Am. Chem. Soc.* **1998**, *120*, 8055 - 8059.
- (42) Glick, H.; Likhotvorik, I. R.; Jones, M. *Tetrahedron Lett.* **1995**, *36*, 5715.
- (43) Baird, N. C.; Dewar, M. J. S. *J. Am. Chem. Soc.* **1967**, *89*, 3966.
- (44) (a) Mabry, J. E.; Johnson, R. P. manuscript in preparation. (b) Mabry, J. E.; Johnson, R. P. Abstracts, 220th ACS National Meeting August 20-24, 2000, Washington, D.C.

## Upcoming Meetings

### **1<sup>ST</sup> FRENCH MEETING OF ENVIRONMENTAL CHEMISTRY AND 1<sup>ST</sup> FRENCH MEETING ON STABLE ISOTOPES**

December 13 – 15, 2000 Nancy France

Palais de Congrès, Nancy (France)

Information: Dr. Eric Lichtfouse INRA-ENSAIA/INPL, BP 172,54505 Vandoeuvre lès-Nancy cedex, France, Tel. & fax (33) 83 59 58 99

email: [eric.lichtfous@ensaia.inpl-nancy.fr](mailto:eric.lichtfous@ensaia.inpl-nancy.fr)

### **PACIFICHEM 2000**

December 14 – 19, 2000 Honolulu, Hawaii

Information: <http://www.acs.org/meetings/pacific.2000>

## **2001**

### **6<sup>th</sup> INTERNATIONAL CONFERENCE ON SOLAR ENERGY AND APPLIED PHOTOCHEMISTRY (SOLAR'01) AND 3<sup>RD</sup> INTERNATIONAL WORKSHOP ON ENVIRONMENTAL PHOTOCHEMISTRY (ENPHO'01)**

April 3 – 8, 2001 Cairo, Egypt

Information: Prof. S. A. Abdel-Mottaleb, Photoenergy Center, Faculty of Science, Ain Shams University, Abbassia, Cairo, Egypt,

Tel: +202 248 9725; fax: +202 484 5941; email: [solar@link.com.eg](mailto:solar@link.com.eg) <http://www.photoenerg.org/solar'01>

### **XIIth INTER-AMERICAN PHOTOCHEMISTRY SOCIETY CONFERENCE**

May 20 – 25, 2001 Ascochinga, Córdoba, Argentina

Information: Prof. Pedro Aramendia, Depto de Química Inorgánica, University of Buenos Aires, Pabellón 2, Ciudad Universitaria, C1428EHA Buenos Aires,

email: [pedro@ql.fcen.uba.ar](mailto:pedro@ql.fcen.uba.ar)

**14<sup>th</sup> INTERNATIONAL SYMPOSIUM ON PHOTOCHEMISTRY AND PHOTOPHYSICS OF  
COORDINATION COMPOUNDS (14T ISPPCC)**

July 7 – 12, 2001 Veszprém, Hungary

Information: Prof. Attila Horváth, Department of General and Inorganic Chemistry, University of Veszprém, H-8201, Veszprém, P. O. Box 158, Hungary

Tel/fax +36 88 427 915, email: [ISPPCC@vegic.sol.vein.hu](mailto:ISPPCC@vegic.sol.vein.hu)

website: <http://www.vein.hu/conference/ISPPCC>

If you wish to contribute to, or participate on, the symposium, please fill the Preliminary Registration Form which you can download from the ISPPCC2001 homepage, and send it back by either email or mail.

**XX INTERNATIONAL CONFERENCE ON PHOTOCHEMISTRY**

July 31 – August 3 2001 Moscow, Russia

Information: Prof. Dr. Michael Alfimov, Photochemistry Center of Russian Academy of Sciences, 7a Novatorov str., Moscow 117421, Russia;

email: [barva@photonics.ru](mailto:barva@photonics.ru)

**V<sup>th</sup> FEMTOCHEMISTRY CONFERENCE**

September 1 – 5, 2001 Toledo Spain

Informations: Prof. Abderrazak Douhal

Tel +34 925 265717; fax: +34 925 268840; email: [femto@correo.amb-to.uclm.es](mailto:femto@correo.amb-to.uclm.es)

**5<sup>th</sup> INTERNATIONAL CONFERENCE ON ATOMIC AND MOLECULAR PULSED LASERS**

September 2001 Academy Congress Hall, Tomsk, Russia

Information: Prof. V. Tarasenko, Institute of High Current Electronics, 4, Academicheskii ave., Tomsk, 634055,

Tel:+7 3822 25 99 89, fax: +7 3822 25 94 10, email: [qel@asd.iao.tsc.ru](mailto:qel@asd.iao.tsc.ru), webpage: <http://sump.iao.ru>